

UC-NRLF

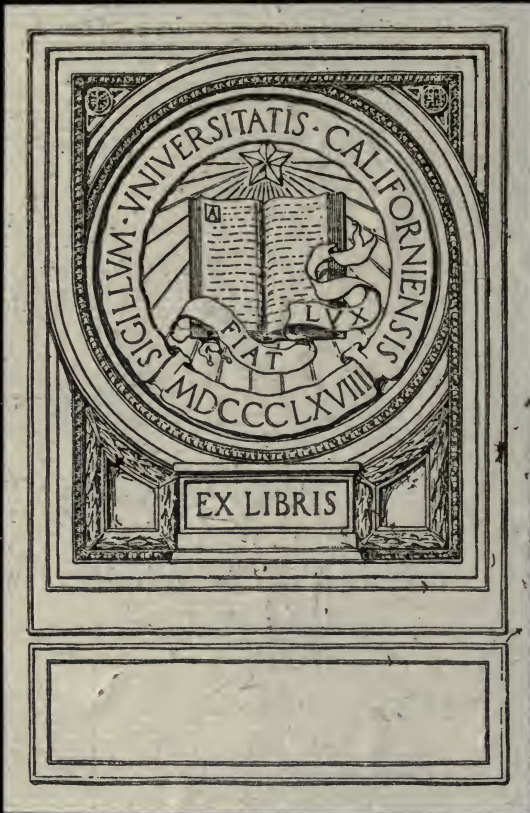

QB 16 298





Digitized by the Internet Archive
in 2007 with funding from
Microsoft Corporation

**HIGH-EXPLOSIVE SHELL
MANUFACTURE**

MACHINERY



HIGH-EXPLOSIVE SHELL MANUFACTURE

A COMPREHENSIVE TREATISE ON THE FORGING,
MACHINING AND HEAT-TREATMENT OF HIGH-EX-
PLOSIVE SHELLS AND THE MANUFACTURE OF
CARTRIDGE CASES, PRIMERS, AND FUSES, GIVING
COMPLETE DIRECTIONS FOR TOOL EQUIPMENT
AND METHODS OF SETTING UP MACHINES,
TOGETHER WITH A REVIEW OF THE MAKING OF
POWDERS, HIGH EXPLOSIVES, AND FULMINATES

By DOUGLAS T. HAMILTON

ASSOCIATE EDITOR OF MACHINERY

AUTHOR OF "ADVANCED GRINDING PRACTICE,"

"AUTOMATIC SCREW MACHINE PRACTICE,"

"SHRAPNEL SHELL MANUFACTURE,"

"CARTRIDGE MANUFACTURE," ETC.

FIRST EDITION

NEW YORK

THE INDUSTRIAL PRESS

LONDON: THE MACHINERY PUBLISHING CO., LTD.

1916

UF760
H26

COPYRIGHT, 1916
BY
THE INDUSTRIAL PRESS
NEW YORK

Small, faint, illegible markings or text at the bottom of the page.

PREFACE

The manufacture of high-explosive shells has, within the past year, become one of the most important of the mechanical industries in this country, and the design of these shells and the machining of their component parts are now of the greatest interest to a large number of manufacturers, designers, toolmakers, and mechanics in general. Machine tool builders have been called upon to provide tools and devices of standard and special design to meet the demand for rapid and accurate production. As a result, there has been a remarkable development in the tool equipment, and in the methods used in the forging and machining of shells. The larger sizes of high-explosive shells are made mainly from forgings, while the smaller sizes are made from bar stock. The forged shell blanks are made by means of hydraulic forging presses, bulldozers or special forging machines that have been developed primarily for this class of work. When made from bar stock, high-powered drilling machines or similar machines of special construction are used. Great developments have taken place in regard to the machines suitable for high-power drilling.

This book, which is a companion volume of the treatise already published on "Shrapnel Manufacture," has been brought out to meet the demand for a comprehensive book dealing with the construction, forging, machining, heat-treatment, inspection, and testing of high-explosive shells. It covers completely the methods of machining these shells when made either from bar stock or from forged blanks. In addition, the manufacture of high-explosive or detonating fuses, cartridge cases, primers, etc., is dealt with in detail. In the book is included all the material on the subject published during the past year in MACHINERY, supplemented by other material wherever necessary to complete the treatise.

The different classes of powder, high-explosives, and fulminates have also been described, and a brief outline is

given of their manufacture. An endeavor has also been made to indicate the difficulties that manufacturers have met with in the making of high-explosive shells. Due to the fact that the information given is very complete and covers all the different phases of the work, it is believed that the book will prove a valuable companion volume to those already brought out by the Publishers of MACHINERY on the manufacture of munitions.

D. T. H.

New York, *January*, 1916.

CONTENTS

	PAGES
CHAPTER I. High-explosive and Armor-piercing Shells	1-31
CHAPTER II. Explosives, Detonators and Fulminates.	32-41
CHAPTER III. Forging High-explosive Shells.....	42-52
CHAPTER IV. Machining British 18-pound Shells.....	53-79
CHAPTER V. Machining Russian and Serbian Shells.	80-99
CHAPTER VI. Machining French 120-millimeter (4.72- inch) Shells	100-126
CHAPTER VII. Machining British Howitzer Shells....	127-144
CHAPTER VIII. Miscellaneous Tools and Devices for Shell Manufacture	145-162
CHAPTER IX. British High-explosive Detonating Fuse	163-180
CHAPTER X. High-explosive Cartridge Case Manu- facture	181-211
CHAPTER XI. Making Cases with Bulldozers and Planers	212-224
CHAPTER XII. Cost of Munitions of War.....	225-227

HIGH-EXPLOSIVE SHELL MANUFACTURE

CHAPTER I

HIGH-EXPLOSIVE AND ARMOR-PIERCING SHELLS

THE common high-explosive shell which is used chiefly for the destruction of fortifications did not come into general use until the latter part of the sixteenth century. About that time, hollow balls of cast iron were filled partly with black gunpowder and partly with a slow-burning composition that was ignited by several different types of fuses. These shells did not give very satisfactory results. An improvement was made by fitting into the shell a hollow forged iron or copper plug filled with slow-burning powder. Until about 1871, the shells were spherical in shape and were fired from smooth-bored guns (not rifled).

Development of High-explosive Shells.— Upon the advent of the rifled gun, sabots, as shown in Fig. 1, were fastened to the base of the spherical shell and took the rifling grooves in the gun. These were usually made of wood and the rim was covered with sheet iron, steel, or copper. When the first types of high-explosive shells burst, they broke into comparatively large pieces, and did not have a very destructive effect. Later developments consisted in making the shells from cast or forged steel and filling them with high-explosives such as lyddite, melenite, shimose, etc., instead of common black gunpowder. These shells were sometimes cast in sand molds, head downwards, from steel of the proper composition to give the required strength. They were then annealed by being left in a furnace until brought to a red heat, when they were removed and allowed to cool gradually in the air. The interior of the cast shell was seldom machined, except at the base end for the insertion

of the base fuse, and the exterior was ground or finished in a lathe and grooved at the base end to form a seat for the rotating band.

Types of High-explosive Shells.— There are in use at the present time four types of shells that may be said to be high-explosive. The first, but not the most common, is known as the high-explosive shrapnel shell. This type of projectile, shown at A, Fig. 2, combines the principles of both the high-explosive shell and the common shrapnel shell, and has been used by some governments within the

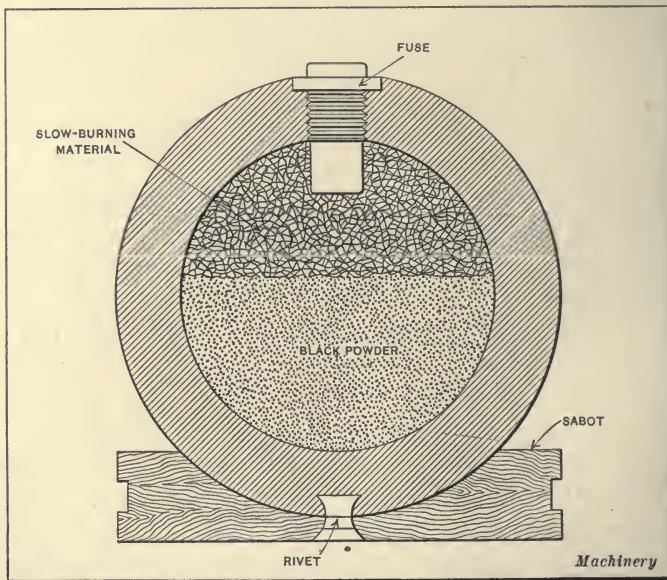

Fig. 1. Original Cast-Iron Spherical High-explosive Shell

past four or five years. In this shell, the head or fuse carries a high-explosive charge and the matrix surrounding the bullets is a high-explosive material capable of being detonated by the detonation of the fuse. This projectile carries a combination time and percussion fuse and a base charge of black powder similar to the common shrapnel. For use as a common shrapnel, the fuse and bullets are expelled without any detonation, the matrix serving to produce smoke as in the common shrapnel. The head or fuse

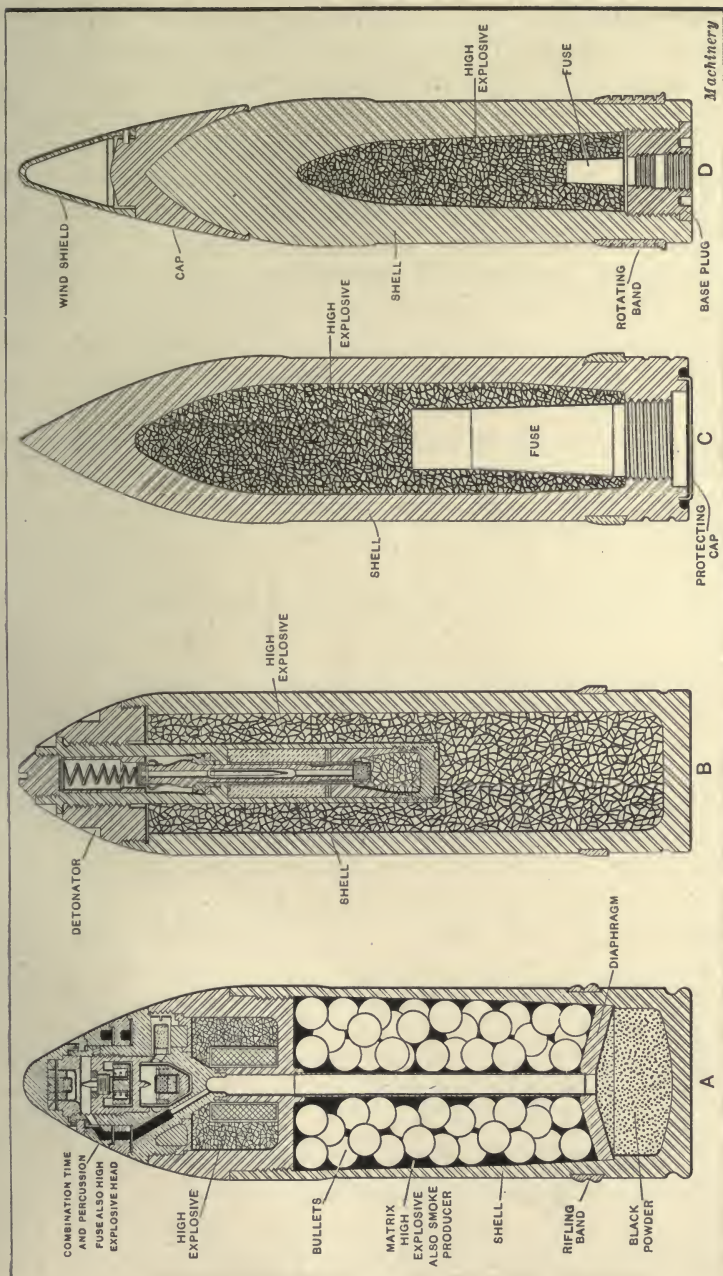

Fig. 2. Diagrammatic Views of Different Types of High-explosive and Armor-piercing Shells

continues in flight and detonates upon impact, causing considerable damage, and is capable of destroying the shield used in protecting a field gun. In the event that the fuse is set to explode upon impact, the high-explosive material in the head and the matrix in the shell detonate together, thus giving the effect of a high-explosive shell. The explosive commonly used in the head and as a matrix in this class of ammunition is trinitrotoluol, which is used in connection with fulminate of mercury, or other similar materials necessary to start the detonation. Fig. 4 shows the condition of one of these shells after being detonated upon impact, this shell not having filled the function of a common shrapnel shell. The projectile shown here is an American 3-inch caliber, high-explosive shrapnel weighing 15 pounds.

Common High-explosive Shell. — The shell shown at *B*, Fig. 2, is known as a common high-explosive shell, and is the type used in medium-caliber field guns by the Russian government. The fuse or exploder is inserted in the nose end of the shell, and usually surrounded by a high-explosive — picric acid, lyddite, melenite, trinitrotoluol, etc. This shell is used principally against fortifications, although it can be used to some extent for field operations. It explodes upon impact and possesses enormous destructive power. Some idea of the great damage wrought by a modern high-explosive shell will be obtained by referring to Fig. 5, which shows the condition of an American 3-inch high-explosive shell after bursting. The fragments were obtained by exploding the shell in an enclosed sand pit.

Delay-action Fuse Shells. — The shell shown at *C*, Fig. 2, is used in coast defense and field guns and carries a fuse located in the base. When used by the American government in field guns, it is equipped with a delay-action fuse and carries from 3 to 30 per cent of its weight of high-explosive. The lighter charged shells are used for repelling infantry attacks, whereas, the heavier charged shells are used for destroying fortifications. One of these types is used as an armor-piercing shell; this contains a very large bursting charge and is furnished with a quick-acting fuse. It is used principally to repel attacks of light-armored vessels or for

attacking the upper works of heavily-armored ships. It accomplishes its purpose by exploding upon impact, driving in the thin plates and destroying those parts not protected by heavy armor.

The type of shell shown at *D* is also known as an armor-piercing shell. This carries a much lighter explosive charge than the shell shown at *C*, and is made with much thicker walls. This shell carries a delay-action fuse, which permits the projectile to pass through the armor plate and into the interior of the vessel before exploding.

Construction of Modern High-explosive Shells. — High-explosive shells are made at present in a variety of shapes and sizes, ranging all the way from 1.4 to 16 inches in diameter and from 1 to 2400 pounds in weight. The shells used by various governments also differ considerably in construction. For instance, the American government uses a solid-point nose shell as shown at *A*, Fig. 3, which is almost the same in construction as the armor-piercing shell and can be used against light-armored cruisers or the upper works of heavily-armored ships. The shell is provided with a rifling band near the base and also with an inserted bronze plug in which the base type of fuse is held. The type of fuse used varies with the use to be made of the shell. For instance, in mountain guns, howitzers, and mortars, a centrifugal type of fuse, as shown, is generally used; whereas, for high-velocity field guns, a ring-resistance fuse is generally employed. The cartridge case and primer held in the base are similar in construction to those used on shrapnel shells. This type of high-explosive shell explodes upon impact only and the cavity is filled with an explosive called explosive "D" from its inventor Lieut.-Col. B. W. Dunn; it is also sometimes known as "dunnite." Dunnite is not a sensitive explosive; consequently, quite a heavy detonating charge is used. The detonating composition is made of picric acid in various portions or T. N. T. (trinitrotoluol).

British 18-pounder Shell. — The British 18-pounder high-explosive shell is shown at *B*, Fig. 3. This shell is provided with very thick walls and carries a charge of high-explosive, generally lyddite. A nose fuse instead of a base fuse is

HIGH-EXPLOSIVE SHELLS

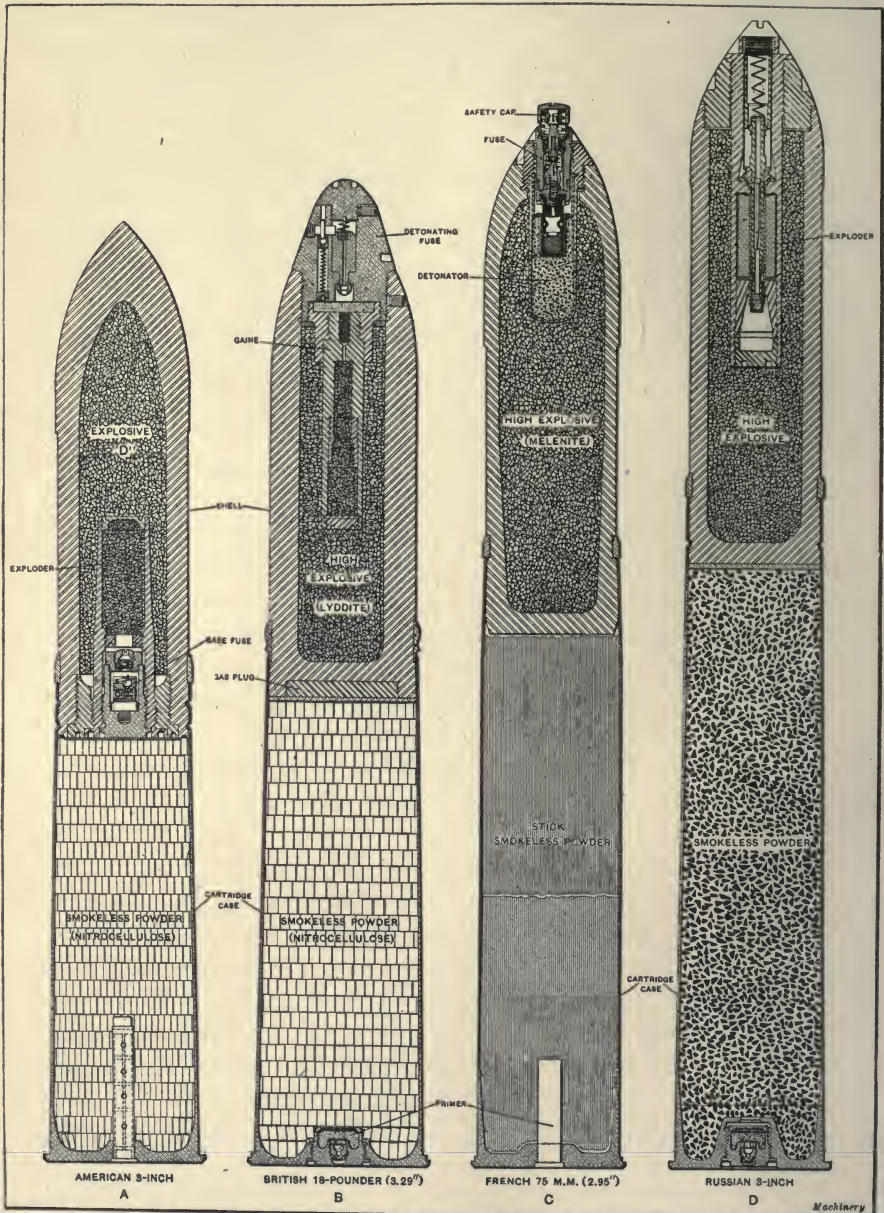

Fig. 3. Types of High-explosive Shells used by American, British, French, and Russian Governments

used and the fuse operates on percussion only. In order that the lyddite will be satisfactorily detonated, the fuse has an extension known as a gaine, which continues into the cavity of the shell for quite a distance. This gaine is filled with three different detonating materials, each successive one being more powerful than the last. In other words, this shell is set off by what is known as the delay-action fuse. This allows the shell to penetrate fortifications or earthworks before it is detonated, and, consequently, enables the explosion to have a much more destructive effect than if it took place instantaneously upon impact. This particular size of high-explosive shell is generally made from bar stock and, in order to avoid chances of piping, a gas plug is inserted in the base of the shell, as shown. The cartridge case and primer held in the base are the same as those used on the shrapnel shell.

French 75-millimeter Shell. — The now famous French 75-millimeter high-explosive shell is shown at *C*, Fig. 3. This shell is made from a forging having comparatively thin walls, and is hardened and heat-treated to increase its elastic limit and tensile strength. It also carries in the nose a delay-action fuse that is of interesting construction. The cavity in the shell is generally filled with a high-explosive known as melenite, the base of which is picric acid. The melenite is poured into the cavity of the shell while in a liquid form and solidifies upon cooling. The exploder, shown extending from the end of the fuse into the explosive, is filled with melenite in powder form. The characteristics of the détonator and bursting charge have to be similar in order that the greatest possible shattering effect may be produced. The fuse used in this shell is also of the delay-action type and enables the projectile to penetrate earthworks or fortifications before detonation takes place. The cartridge case is similar to that used on the shrapnel shell and is filled with smokeless powder (nitrocellulose) in stick form.

Russian 3-inch Shell. — The Russian 3-inch high-explosive shell is shown at *D*, Fig. 3. The shell proper is made from a forging that is heat-treated before or after machin-



Fig. 4. Condition of an American 3-inch High-explosive Shrapnel after being exploded upon Impact. (Annual Report, Smithsonian Institute, 1914)

ing, depending on the practice followed. It must have an elastic limit of not less than 62,000 pounds per square inch and a tensile strength of 118,000 pounds per square inch. This shell also carries in its nose a detonating fuse, which, however, differs considerably from any of the fuses previously illustrated. This fuse is practically instantaneous and detonates the high-explosive material in the shell upon impact. The cartridge case carries a heavy charge of smokeless powder—generally nitrocellulose—and also a primer in the base end somewhat similar in construction to that used in the British shell. This projectile has a muzzle velocity of over 1900 feet per second; and, as the shell proper is heat-treated, it has considerable destructive effect when the high-explosive contained within it is detonated.

Armor-piercing Projectiles.—Following the introduction of iron sheathing for ships, it was found that the ordinary cast-iron high-explosive projectile did not readily pierce the plate, so that it became necessary to produce a projectile that would do so. This was accomplished by Sir W. Palliser, who invented the method of hardening the head of the pointed cast-iron shell by casting the projectile point downwards and forming the head in an iron mold; the metal at the point being suddenly chilled became intensely hard, while the rest of the casting remained comparatively soft. The casting when partly cold was taken out of the mold and thrown down into the sand, where it was allowed to cool off gradually. These shells proved very effective against wrought-iron armor, but had little effect against steel armor plates. An improved shell was then devised which was made from forged steel with a point hardened so as to pierce the armor; this projectile is generally formed from steel containing both nickel and chromium, and sometimes tungsten. Armor-piercing shells are generally cast from a special mixture of chrome-nickel steel, melted in a crucible and afterwards forged into shape. The shell is then thoroughly annealed, bored internally, and turned on the exterior in a lathe. The heat-treatment consists in hardening the head of the projectile and tempering it in such a manner that the rear portion is reduced in hardness so as to

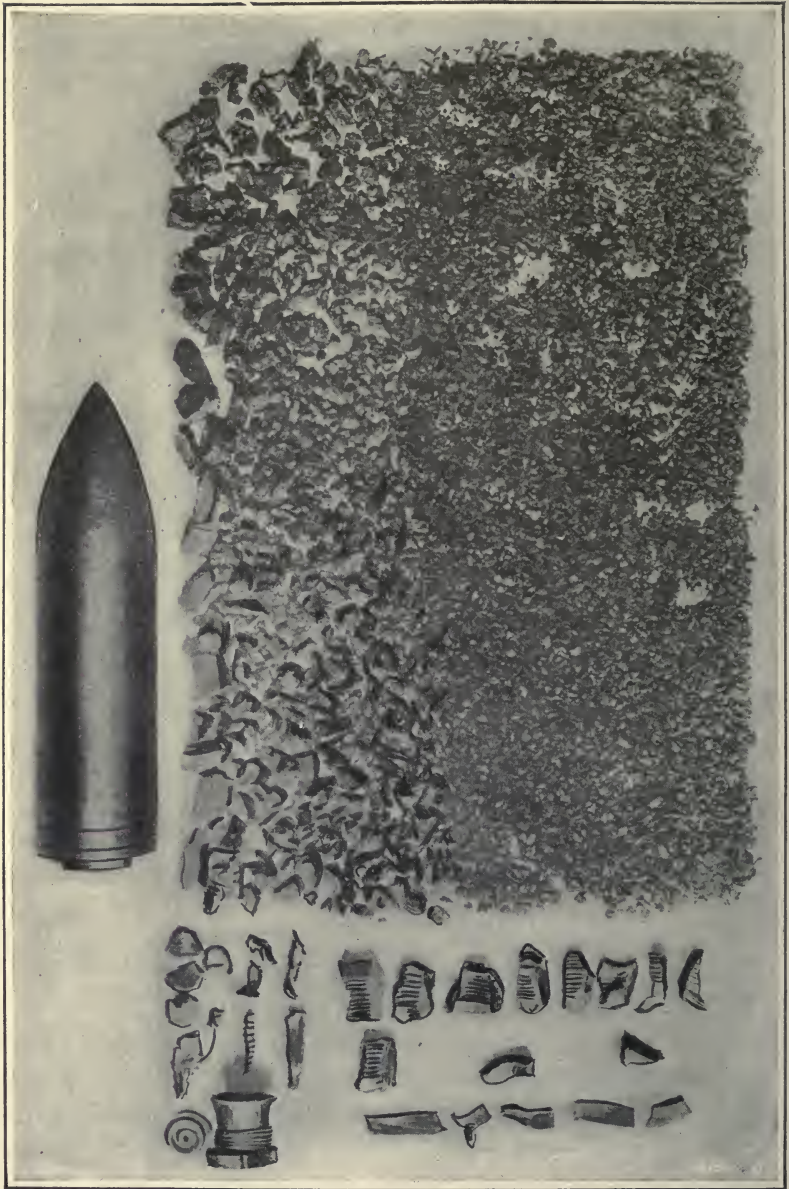

Fig. 5. Condition of a 3-Inch American Common High-explosive Shell after passing through a Steel Plate and Into a Bank of Sand, and after bursting. (Annual Report, Smithsonian Institution, 1914)

render it extremely tough, whereas, the point is extremely hard. There are two types of armor-piercing shells: One, known as a shot, is used for piercing armor and carries a light bursting charge; the other, known as a shell, carries a much heavier bursting charge, is longer, has thinner walls, and is much more destructive.

Capped Projectiles. — As shown at *D*, Fig. 2, the armor-piercing shell is similar in shape to the common high-explosive shell shown at *C*, with the exception that the walls are much thicker and the point is still thicker. In order to greatly reduce the air resistance encountered in flight, armor-piercing shells are provided with a long pointed outer covering for the head. It was also found that if an armor-piercing shell having a hardened nose struck an armor plate with great force, the force of the blow shattered the head and made it ineffective. A soft steel cap placed on the shell, supports the point and greatly improves the chances of the projectile getting through a hard armor plate unbroken. One of the plausible theories advanced as to the ineffectiveness of an uncapped head is: When an uncapped projectile strikes the extremely hard face of a modern armor plate, the whole energy of the projectile is applied at the point and the high resistance of the face of the plate puts the very small arc at the point of the projectile to a stress greater than the metal can resist. The point is therefore broken or crushed and the head of the projectile is flattened; this greatly reduces the penetrating power and results in the point of the projectile being practically welded to the armor plate. When a capped projectile strikes a hard plate, the resistance of the plate is distributed over a greater area, and the point is supported by the cap. Consequently, the point is not deformed and passes through the plate.

The specifications for the test governing the manufacture of armor-piercing projectiles are very stringent and require that the shell perforate a hard-face armor plate as thick as the caliber of the projectile without breaking the point. In other words, a 6-inch projectile is required to completely pass through a 6-inch armor plate in an unbroken condition.

General Methods of Manufacture.— At present, there are two general methods of manufacturing high-explosive shells. One is to make the shell from bar stock, removing the excess material to form the cavity by means of high-power drilling machines; the other is to forge the shell to approximately the correct shape. Until within the last few years, cast-iron shells were used quite extensively; these were cast in sand molds using a core to form the cavity. Great difficulty, however, was experienced in obtaining a casting free from flaws and other imperfections, so this method has generally been superseded by either the forged or bar-stock shell. When the shell is made from bar stock, it is usually necessary to fit a gas plug in the base end to eliminate any chances of piping. At present, cast-iron shells are still used for target practice.

High-explosive shells are made in three distinct types. Those with a solid base carrying a nose fuse, those with a solid nose carrying a base fuse, and those with an open nose and base carrying a nose fuse. If the shell is intended to carry a nose fuse, the base end is shaped in forging by the press and the nose subsequently formed to shape by a nosing-in die. In small shells of about 2 inches in diameter, the nose when red-hot can be spun over in the lathe by properly formed tools. However, it is usually closed in by a press. For base fuse shells, the nose is produced by the forging machine and the base is subsequently formed by pressing the metal to the required shape.

Operations on British Forged Shells.— Generally speaking, the operations on a British high-explosive shell when made from forgings are as follows: Bar stock of the required diameter is first cut off into billet lengths, which are heated to about 1900 degrees F. (about 1040 degrees C.), and by subsequent piercing and drawing operations are drawn out to the correct length and diameter. Following this, the mouth end and base end are trimmed and faced off. Then several operations are performed on the external diameter of the shell, such as turning, grooving, etc. The shell is then held in a chuck and several operations are performed on the cavity, after which it is nosed-in; the final operations

consist in machining the nose, pressing on the band, machining it, testing, etc. After the shell has been completely machined, it is filled with lyddite. In filling the shell, great precautions are taken to prevent the melted lyddite (which contains picric acid) from coming into contact with certain materials, such as combinations of lead and soda, which produce sensitive picrates. The shells are consequently painted externally with a special non-lead paint and lacquered internally with a special lacquer. The picric acid is then melted in a pot, the temperature being carefully controlled, and certain ingredients are added to reduce the melting temperature of the acid. The melted material is then poured into the shell through a bronze funnel, the latter forming a space for the exploder. In cooling, the material solidifies into a dense hard mass.

Operations on French Forged Shells. — The French high-explosive shell was adopted in 1886. The high-explosive used in this shell was melenite, which was originally put into an ordinary cast-iron common shell having thick walls. Afterwards, a forged steel thin-walled shell was introduced, as shown at *C*, Fig. 3; this is hardened and heat-treated in order to give it the correct tensile strength. The operations on the French shell differ from those on the British shell in that no machining is done on the inside of the shell or the cavity. The general manufacturing methods on this shell are first cutting off a billet of the required length, heating, and forging. Usually the forgings are pickled; then the base end is faced and centered, the external diameter is turned, after which the shell is nosed-in. Following the nosing-in operation, the shell is hardened and tempered, after which it is faced off on the nose end, bored, reamed, threaded, and finally ground or turned on the external diameter; after this the rifling groove is cut and the rifling band pressed in and turned to shape. In order to avoid the formation of picrates, the interior of the shell is lacquered and the external surface painted with a non-acid paint. The melenite is then melted and poured in.

High-explosive Shell Fuses. — Various types and forms of fuses or detonators are used in high-explosive shells, some

governments using a plain type of concussion fuse held in the base end of the shell, and to which no gaine is attached; this fuse is set off upon the impact of the shell against fortifications or other obstructions. Others use percussion fuses of extremely complicated design which are provided with exploders that extend down into the cavity in the shell; these carry a detonating primer and exploding material for detonating the high-explosive contained in the cavity of the shell. Where ordinary black powder is used to burst the shell, a high-power detonator is not necessary. The direction, or impact, fuses are more simple in construction

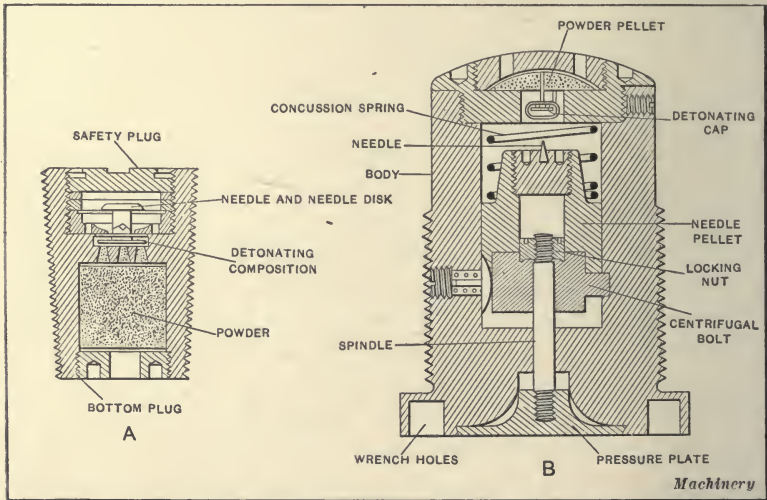

Fig. 6. Common Types of Concussion Fuses used in Nose and Base of High-explosive Shells

than the combination time and percussion fuses, and they are usually made of material that will withstand considerable pressure without crushing.

High-explosive shell fuses may be divided into two distinct groups: Those that explode instantaneously upon impact and those that explode shortly after impact, or, in other words, those in which the detonating action is slightly delayed. From the standpoint of design and operation, these groups are subject to still further divisions. For example, some fuses are started or "unloaded" by the gas pressure

in the gun, others depend on rotation, and some depend on a combination of both; then there are types employing split rings, centrifugal bolts, springs, etc., or a combination of two or more actions.

Common Type of Concussion Fuse. — A common type of concussion, or direct-action, fuse that fits in the nose of the shell and is set off upon impact is shown at A, Fig. 6. The fuse body and other important members are made from steel of sufficient strength to be discharged from the gun without rupture; but, upon striking, the needle disk is crushed in and the needle explodes the detonator, which, in turn, explodes the

powder in the base of the fuse. At B is shown the common type of concussion fuse used in the base of high-explosive shells. Before firing, the needle pellet is held by a central spindle

that has a pressure plate attached to its rear end. A centrifugal bolt is also inserted for additional safety, which is released by the rotation of the shell. In action, this fuse works as follows: On the discharge of the projectile from the gun, the gas pressure pushes in the pressure plate so that the central spindle is carried forward, unlocking the centrifugal bolt. The needle pellet is then free to move forward and explode the detonating cap when the shell strikes. These two types of fuses are not very extensively used at the present time, and have been superseded, in general, by more complicated but effective fuses.

American Base Percussion Fuse.—In American high-explosive shells fired from one- and two-pounders, as well as from six-pounders and 2.38-inch field guns, the type of fuse shown in Fig. 7 is used. This fuse is of simple construction and depends for its action on the expanding of a split ring A. As the primer end of the fuse is toward the interior of the shell, the flame passes from the priming charge B directly

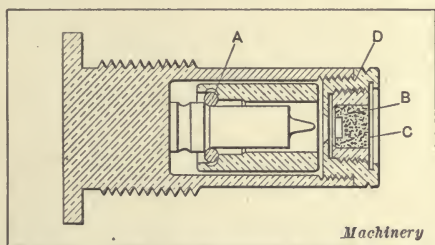

Fig. 7. Base Fuse used in American Small- and Medium-caliber High-explosive Shells

to the bursting charge in the shell without passing through the body of the fuse itself. The primer cup contains the percussion composition and priming charge, and is enclosed at its outer end by a brass disk *C* secured in place by crimping over the outer end of the primer holder, or brass closing screw *D*. The act of arming this fuse is simple, and depends on the expanding of the split ring, which is accomplished when the shell strikes a solid body.

Centrifugal Type of Base Percussion Fuse.—In the case of ring-resistance fuses, or, in fact, in any fuse the action of which depends on the longitudinal stresses developed by the pressure in the gun, the conditions of safety in handling and certainty of action are not all that could

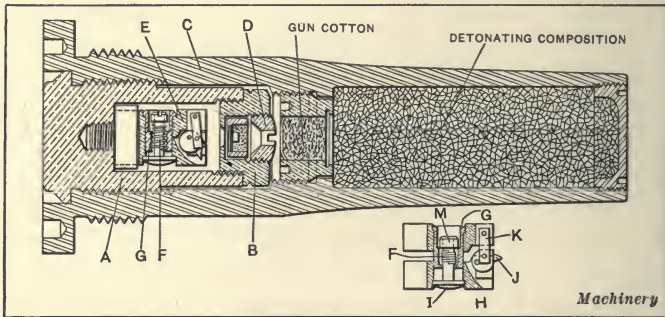

Fig. 8. Frankford Arsenal Centrifugal Type of Base Percussion Fuse

be desired. A fuse that is armed by the centrifugal force developed by the rotation of the projectile, and which is safe until the maximum velocity of rotation is nearly obtained, is the Frankford arsenal fuse shown in Fig. 8, where a separate view of the expanding centrifugal plunger presents the firing pin in the armed position.

This fuse is used in shells fired from mountain guns, howitzers, and mortars. It is made up of the body *A* and the closing screw *B*, which are held in the steel stock *C*; this stock also carries the detonating charge. The primer or detonating agent is also held in the nose of the fuse, and, to reach the exploder, the flame passes through a small vent in the primer closing screw *D* to the guncotton, which facil-

itates and increases the igniting effect. The centrifugal plunger, shown in the armed position at *H*, is made in two parts. When the fuse is at rest, these are held together by the pressure of a spiral spring *F* contained in the cylindrical bushing *G* secured to each end of the plunger halves. The spring exerts its pressure on half of the plunger through the bolt *I*. Pivoted in a recess in one half of the plunger is the firing pin *J*, which, when the fuse is at rest, is held with its point below the front surface of the plunger by the lever action of the link *K* that is pivoted to the other half. When subjected to the action of centrifugal force developed by the rapid rotation of the projectile in passing from the bore of the gun, the two halves of the plunger separate. This separating movement causes the rotation of the firing pin *J*, the point of which is now held in advance of the front surface of the plunger, to pierce the brass primer shield and ignite the detonating composition. When the fuse is armed, the end of the link *K* rests on the pivot of the firing pin, thus affording support to the firing pin when it strikes the percussion primer. The amount of separation of the plunger parts is limited by the nut *M* coming to a bearing on a shoulder in the bushing *G*, and thus preventing the diameter of the expanding plunger from equalling the full diameter of the hole in the fuse body. A stud screwed into the head of the fuse stock engages a corresponding slot cut through the bottom of both plunger halves and insures the rotation of the plunger with the shell. The strength of the spring *F* is adjusted so that the fuse will not arm until its rapidity of rotation is a certain percentage of that exerted in the shell in which it is used, and so that it will surely arm whenever the rapidity of revolution approximates the speed of rotation of the shell when fired. In the case of the parts of the plunger being accidentally separated and the fuse armed by a sudden jolt or jar in transportation or handling, the reaction of this spring will immediately bring the plunger back to its unarmed position.

British High-explosive Fuse.—The fuse shown in Fig. 9 is known as the British 100-graze high-explosive fuse, and

is used in British high-explosive shells that are fired from field and mountain guns. This fuse explodes upon impact only and screws into the nose of the shell; all the parts, except the adapter and gaine, are made from brass or bronze. This fuse operates as follows: When the shell is

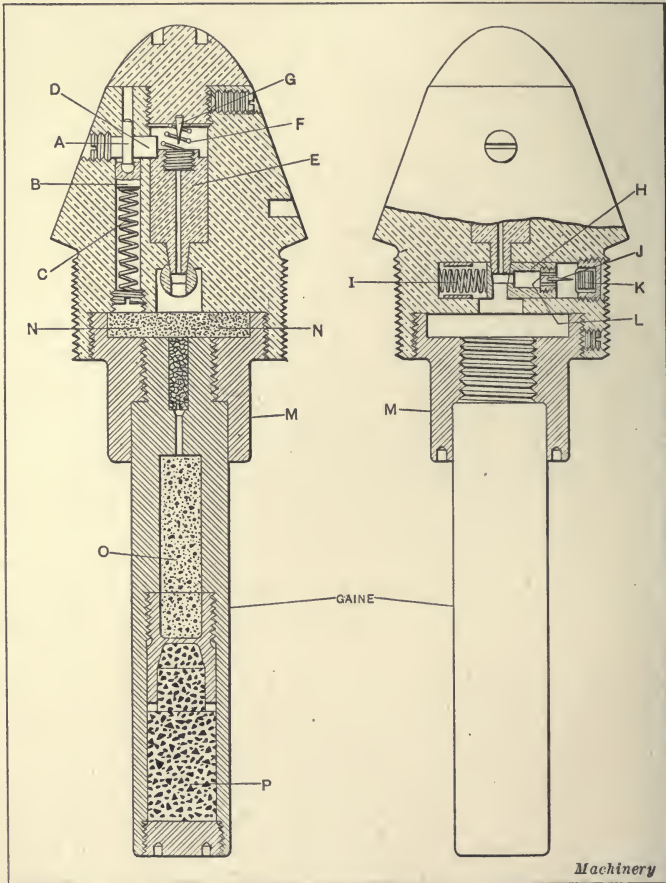

Fig. 9. British No. 100 Graze High-explosive Shell Fuse

fired, and before it commences its rotary motion imparted by the rifling in the gun bore, the impact of the explosive charge in the case causes the combined top and bottom detent *A* and *B*, respectively, to drop back and compress the detent spring *C*. The detent assembly is made in two

pieces; and, as the stem *A* is free to move out of alignment, it drops to one side, by the action of gravity, when it is forced back. It is caught by the edge of the counterbored hole and prevented from taking its original position. By this time, the centrifugal action of the shell throws centrifugal bolt *D*, the path of which is now clear, out of the way of the graze pellet *E*. The only member that now prevents detonation is the hair spring *F*, so the slightest impact causes the relatively heavy graze pellet to jump forward and explode the shell. The primer that is held in the counterbored end of the graze pellet is exploded upon impact with needle *G*, and from here the flame extends down into the other explosives in the gaine. The primer in pellet *E* is loaded with a composition composed of 45 parts chlorate of potassium, 23 parts sulphide of antimony, and 32 parts fulminate of mercury. The different constituents are measured by weight, and are loaded into the primer cup under a pressure of 600 pounds, after which the cup carrying the explosive charge is dried.

Should the primer in the pellet *E*, for any reason, fail to explode, a second detonation takes place simultaneously. As shown by the view to the right, the lower end of pellet *E* is tapered and seated in a cross-hole in the percussion pellet *H*. When the graze pellet moves forward, pellet *H* is released and the centrifugal action combined with spring *I* drives the pellet carrying needle *J* against primer *K*, exploding it. The flame passes through four small holes in the needle holder *L*, thence into the chamber and down into the gaine containing the detonating charges.

The gaine is held to the fuse body by adapter *M*. Its three chambers, *N*, *O*, and *P*, contain different high-explosives, each succeeding one being of greater power than the last. Chamber *P* is filled with lyddite in flake form. The flame from the detonating primers first explodes the material in chamber *N*, then that in chamber *O*, and then that in chamber *P*, which causes such a terrific shattering effect that the lyddite in the shell is detonated and blows the shell to atoms—some parts to the fineness of sand. It is stated upon good authority that, after a shell has been detonated,

it is impossible to find the gaine or its parts, so terrific is the effect of the explosion.

Russian High-explosive Fuse. — The Russian high-explosive fuse or detonating head used in high-explosive shells is shown in Fig. 10; the gaine is a part of the head and extends into the explosive material in the cavity of the shell.

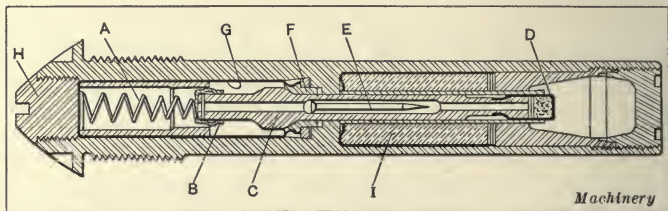

Fig. 10. Russian High-explosive Shell Detonating Head

This fuse operates in the following manner: The force of impact of the shell against a solid body overcomes the resistance of spring *A* and stirrup *B*, allowing striker rod *C* to move forward into the cavity occupied by spring *A*. Attached to the lower end of striker rod *C* is a detonator pellet *D*, which carries a charge of mercury fulminate, and, in coming in contact with the steel needle *E*, is exploded.

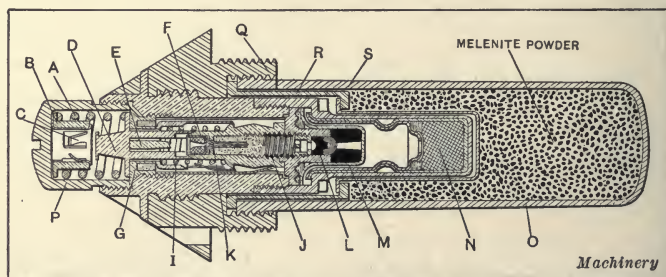

Fig. 11. French Detonating Fuse for Use in 75-millimeter High-explosive Shells

When exploded, pellet *D* is midway along the interior of the "tetryl" cartridge *I* that surrounds the striker rod *C*, so that the latter is detonated, and, in turn, explodes the high-explosive material held in the cavity of the shell. Needle *E* is held in a steel plug *F*, which is kept from moving up with the striker rod *C* by a striker casing *G* crimped around it,

and extending up through the body of the fuse, coming in contact with the lower face of the head plug *H*. In order that the body of this detonator will be capable of resisting considerable shock, it is generally made from alloy steel with a tensile strength of about 110,000 pounds per square inch.

French High-explosive Fuse. — A high-explosive shell fuse of the delay-action type used in the French 75-millimeter high-explosive shell is shown in Fig. 11. This is provided with a safety head and is carried in the nose of the shell. In action, this fuse works as follows: On the discharge of the projectile from the bore of the gun, the gas pressure overcomes the resistance of spring *A*, causing bushing *B* to drop back; the stirrup *C*, which is held to it, then grips the head of the plunger *D*. The plunger *D* completely envelops the firing pin *E* and prevents the detonator *F* from being accidentally discharged. When this plunger is withdrawn, it exposes the firing pin *E*, which is riveted to the retainer *G*, and does not move with the plunger.

The fuse is now in the armed position, so, as soon as the projectile strikes a solid body, the resistance of springs *I* and *J* is overcome and the primer *F* makes contact with the firing pin *E*. The flame from the primer *F* ignites the guncotton *K* and the powder surrounding it; this ignites the compressed gunpowder in cups *L* and *M*, which results in quite a powerful explosion and explodes the detonating composition in cup *N*; this, in turn, explodes the detonator *O*, which is filled with melenite in flake form. The fuse does not detonate the high-explosive composition in the shell instantaneously, but causes a series of explosions, finally resulting in the detonation of the melenite in the shell by the exploder that extends into it. All the working parts of this fuse are made from brass or bronze with the exception of the safety cap *P*, nose *Q*, cup *R*, and exploder cup *S*; these are made of steel.

Loading Propelling Charges in Guns and Howitzers. — In the early cannon, the spherical shot and powder charges were rammed in from the muzzle of the gun the same as in loading small arms. It was not until 1845 that a success-

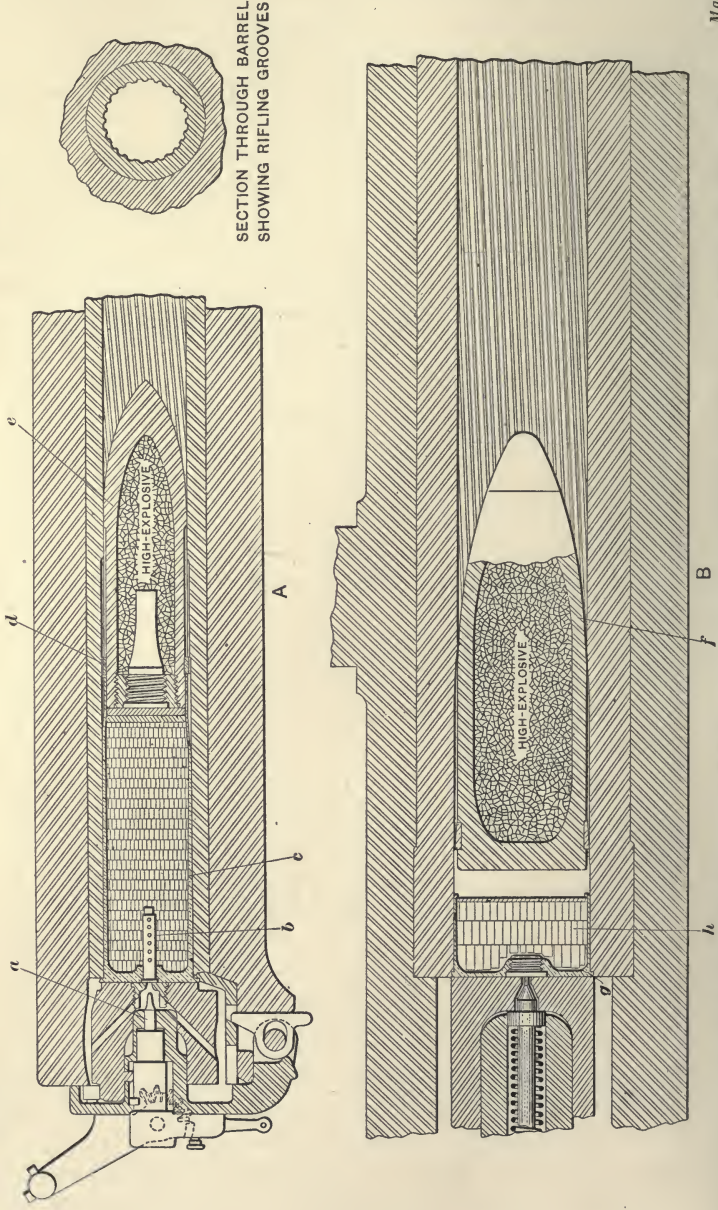

Fig. 12. Diagram illustrating Method of retaining Propelling Charge in Field Guns and Howitzers

ful breech-loading gun was designed; in this case, the projectile, which bore a marked resemblance to the present-day type, was placed in the gun from the breech end with a propelling charge of black powder packed in behind it, the vent being closed by a hinged door. Following this, several types of breech-closing mechanism were developed, and, in England in 1854, the Armstrong breech-loading gun was designed. The projectile and propelling charge, however, were still made up in separate units, and it was not until some time later that fixed ammunition was used in field guns. In early cannon, the barrels were made from either bronze or cast iron, bronze being used for field guns and cast iron for large coast artillery. These two metals were subsequently abandoned, forged steel being used in their place.

Fixed Ammunition. — Fixed ammunition is the name given to that class of shells in which the propelling charge for the projectile is held in a cartridge case attached to the rear end of the projectile. In other words, the projectile, propelling charge, and firing member or primer form a complete unit. The diagram at *A*, Fig. 12, shows a sectional view of a 3-inch field gun with the complete round of ammunition inserted in the breech. It will be noticed that the gun is chambered to receive the projectile and cartridge case, and carries a breech-block containing the striker mechanism. Upon the operation of the striker mechanism, firing pin *a* hits primer *b*, igniting the percussion cap in its head, which, in turn, ignites the black-powder charge in the body of the primer itself. The propellant in the cartridge case *c* is now ignited and almost instantly converted into a gas. The gas thus formed occupies a much greater volume than the original material, with the result that the projectile *e* is started on its journey through the bore of the gun.

As soon as the projectile starts forward, the copper rifling band *d* is forced into the rifling grooves in the bore of the gun, which are located in a helical path. This results in the projectile being rotated at the same time that it advances. In addition, the rifling band also centers the pro-

jectile and prevents the propelling gas from escaping past it. Modern propellants, by virtue of their ingredients, are of the slow-burning variety; consequently, the gas pressure increases, with the result that the projectile increases in velocity from the time that it leaves the breech until it reaches the muzzle of the gun. To provide for this, the rifling grooves in some guns increase in pitch as they reach the muzzle of the gun. For example, in the 3-inch, American, quick-firing field gun, the rifling grooves start at the breech with a twist of one turn in 50 calibers and increase to one turn in 25 calibers at a distance of $2\frac{1}{2}$ calibers from the muzzle. Therefore, as the velocity of the projectile is increased, the speed of rotation upon its axis is accelerated; this partly accounts for the comparatively flat trajectory of the modern high-power quick-firing gun in comparison with the older and less efficient guns.

Loading Howitzers and Mortars. — A howitzer differs from a quick-firing field gun in several ways: The barrel is much shorter; no cartridge case is used (except for medium-caliber howitzers, where a short case is sometimes used); the muzzle velocity is only about one-half that of a quick-firing gun of the same caliber; and a howitzer is used for high-angle firing, particularly against troops protected by entrenchments or other shelter. The diagram *B*, Fig. 12, shows a section through the barrel of a 4.5-inch howitzer. The projectile *f* is not fixed to the cartridge case *g*; in fact, it is separated from it. The difference between this cartridge case and the one shown at *A* is in length only; the length of this cartridge case is about one-half the caliber. The howitzer cartridge case carries a comparatively light propelling charge of smokeless powder *h*, which is held in the case by wads. Having the ammunition arranged in this manner makes it possible to vary the charge according to the results wanted. In larger-bore howitzers, 6-inch caliber, a charge of powder in the form of doughnuts or large disks is used; these are placed directly in the breech of the gun, and no cartridge case is used.

A type of gun that bears a marked resemblance to the howitzer is the mortar, which is classified as field or

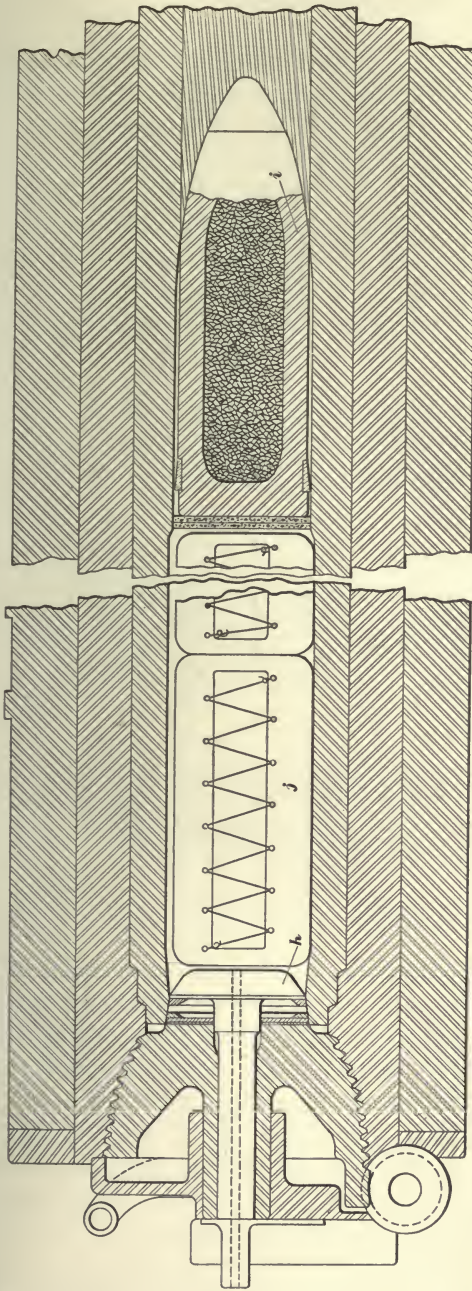

Fig. 13. Diagram illustrating Method of retaining Propelling Charge in 6-inch Gun

trench, and coast-defense mortars. This gun differs from the howitzer only in having a barrel that is still shorter than that of the howitzer. Fixed ammunition is never used in a mortar, and its chief application is for high-angle and vertical firing.

Loading Propelling Charges in Large-caliber Rapid-fire Guns.—Fixed ammunition is used in rapid-fire guns from the 1-pounder (1.45-inch) up to and sometimes including 6-inch guns. In guns of a larger caliber than this, the projectile and pro-

elling charges are separated. Fig. 13 shows a section taken through the chamber and barrel of a 6-inch rapid-fire gun. Here, the projectile *i* is separate; and located between the projectile and the breech-block is a propelling charge of smokeless powder and detonating cap contained in silk bags *j*, the number of bags depending on the size of the gun and the weight of the charge put up in each. These bags are made from raw silk with the ends made double-ply, and between the two pieces at each end

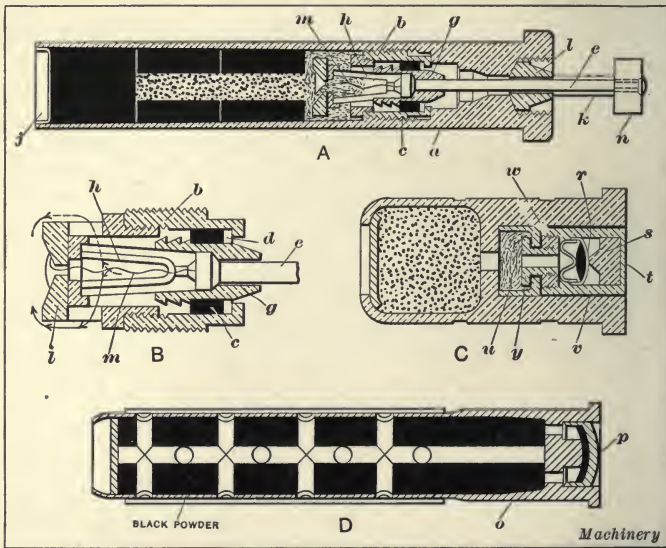

Fig. 14. Friction, Electric and Percussion Primers

is placed a priming charge of black powder quilted in, in squares of about 2 inches, and uniformly spread over the surface. The charge used for propelling a projectile of this particular size of gun weighs about 24 pounds; consequently, only two bags would be needed. The obturator *h* acts as a gas check and at its rear end carries the electric primer. The powder charge is ignited by means of a friction or electric primer shown at *A*, *B*, and *C*, Fig. 14. The primer, of course, is not a part of the propelling charge, but is held in the breech-block of the gun. In larger-bore guns, several bags of smokeless powder are inserted; for instance, in the

16-inch American gun, six bags containing a total of 666.5 pounds of smokeless powder are used.

Friction, Electric, and Percussion Primers. — Various types of primers are used in howitzers and field guns for igniting the propelling charges. For guns using fixed ammunition, the primer is carried in the base of the cartridge case; whereas, for guns firing loose projectiles, the primer is held in the breech-block. Inasmuch as large- and medium-size caliber projectiles are discussed here, two of the principal types of primers used in the breech-blocks are described.

Friction Primers. — Fig. 14 shows the common type of friction primer, which may be fired by friction or electricity. As the frictional and electrical elements are independent, this primer may be fired by friction should it fail to fire by electricity. This primer comprises a brass case *a* held in the breech-block of the gun, and carrying a case *b* enclosing the firing or igniting elements. When used as a friction primer, an annular pellet *c* of friction composition is pressed into the inner case *b* and rests on a vulcanite washer *d*, which prevents it from crumbling when the firing rod *e* is pulled to ignite the primer. The inner end of the firing rod *e* is loosely surrounded by a serrated cylinder *g*, which is embedded up to the serrations in the friction composition. The inner end of the firing rod is provided with a head that operates upon the cylinder *g*, and these parts are securely held in place by forked lever *h* and nut *i*; this end is shown enlarged at *B*.

In operation, when the firing rod *e* is pulled, the serrated cylinder *g* is drawn through the composition *c* and ignites it. As the conical end of the cylinder is then drawn to its seat in the rear part of the primer, it prevents the escape of gas at the rear. The flame from the friction composition passes through vents in the closing nut *i* and ignites the priming charge of compressed and loose black powder in the body of the primer. The resulting explosion blows out the cemented brass cup *j* in the mouth of the primer and allows the flame to pass through the breech-block to the propelling charge in the breech of the gun.

Electric Primers.—In order to adapt this primer for electric firing, the rod *e* is covered with an insulating cylinder *k* and enters the primer through a vulcanite plug *l*. The rod *e* is in electric contact with the serrated cylinder *g*, but this is insulated from the primer body by a washer *d* and the pellet of friction composition, which is a non-conductor of electricity. The electric circuit is completed by a platinum wire *m* soldered to the fork *h* and nut *i* and surrounded by an igniting charge of guncotton.

In operation, when the primer is inserted in the gun, the insulated button *n* on the rod *e* is grasped by an electric contact piece through which the electric current passes. The passage of the electric current then heats the platinum wire, igniting the guncotton and the priming charge of powder.

Percussion Primers.—In fixed ammunition where the cartridge case forms a unit with the projectile, the firing is done by means of a primer held in the cartridge case; *D*, Fig. 14, shows the primer used in the head of American 3-inch cartridge cases. This is known as the 110-grain percussion primer, and consists of a brass case *o* resembling in shape a small-arms cartridge case, in which a percussion cap is held. The head or rear end of the primer case is countersunk to form a cup-shaped recess in which the percussion primer proper *d* is located. The latter consists of a cup, anvil, and percussion composition, which is composed of the following ingredients:

Ingredients	Per Cent
Chlorate of Potash.....	49.6
Sulphide of Antimony.....	25.1
Glass (ground)	16.6
Sulphur	8.7

Owing to the danger involved in the handling of mixtures containing fulminate of mercury, the Frankford arsenal has abandoned this ingredient and substituted the ingredients just given for the service primers.

The percussion cap recess is connected with the interior of the primer case by two small vents. The body of the case contains 110 grains of black powder that constitutes the rear "priming" or igniting charge for the smokeless-powder

propellant. This black powder is inserted in the case under a pressure of 36,000 pounds per square inch, and is pressed into the primer body around a central wire which is then withdrawn, leaving a longitudinal hole the full length of the powder charge. Eight radial holes are then drilled through the primer body and compressed powder, thus affording sixteen vents for the free exit of the black-powder flames to the smokeless-powder charge. After filling the case, the front end is closed by a cardboard wad covered with shellac and the radial perforations are covered by a tin-foil wrapper so as to retain any loose black powder and exclude moisture.

In action, the firing pin hits the percussion cap and explodes it. This ignites the black-powder charge, and the

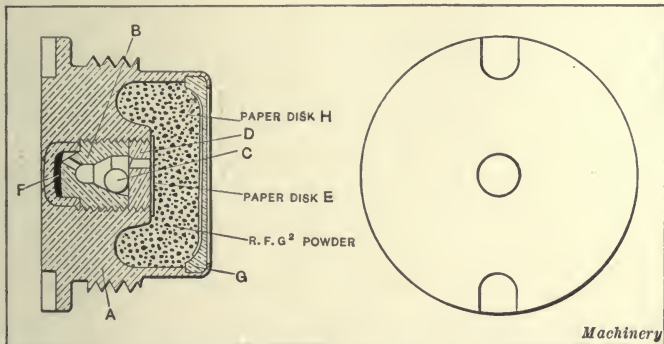

Fig. 15. Percussion Primer used in British Cartridge Cases

flames from the latter shoot out through the vents in the case and ignite the smokeless-powder charge. In order to make the combustion of the smokeless powder complete, a second igniting or priming charge is generally used. In the 3-inch shell, this additional charge consists of $\frac{1}{4}$ ounce of black powder which is contained in a disk-shaped bag placed in the case directly in front of the smokeless-powder charge.

British Percussion Primer.—A percussion primer that differs considerably from that illustrated at *D*, Fig. 14, is shown in Fig. 15; this primer is used in British 18-pound cartridge cases. It comprises a brass cup *A* threaded on the external diameter so as to screw into the pocket in the head

of the case, and recessed and threaded to receive the anvil *B*. This, in turn, is counterbored to receive a brass ball *C* and is also provided with three fire holes. It is backed by a plug *D* that is sealed with a paper disk *E* secured with Pettman's cement. Seated on the head of anvil *B* is the percussion composition, which is pressed into the soft brass cup *F*, and inside of which is a tin-foil washer. The percussion composition, known as the 1.2-grain composition, consists of the following ingredients:

Ingredients	Per Cent
Sulphide of Antimony.....	54.5
Chlorate of Potash.....	36.5
Glass (ground)	3.0
Powder (mealed)	3.0
Sulphur	3.0

In the front end of the primer enclosed by a brass closing disk *G* is a charge of RFG² powder. Separating the closing disk and the powder is a paper disk *H* secured with Pettman's cement. The closing disk *G* is held in place by spinning over the front edge of the cup *A*.

In action, the firing pin comes directly in contact with the percussion cap *F*, exploding it and causing the flames to pass through the vents in the anvil *B* and the plug *D*. The paper disk *E* is thus ignited, together with the powder charge in the front end of the primer. The resulting pressure forces out the center of the closing disk *G*, which is weakened by six radial slots. The flame then passes to the secondary powder charge in the base of the cartridge case, thus effecting complete combustion of the propelling charge. In order to prevent the escape of gas back through the vents in the primer before complete combustion has taken place, a soft brass ball *C* is inserted in the anvil. As soon as the powder in the front of the primer is ignited, the resultant back pressure forces the ball into the circular seat in the anvil and effectively prevents the further escape of gas.

Combination Electric and Percussion Primer.—The United States Navy uses, in rapid-fire guns, a combination electric and percussion primer of the type shown at *C*, Fig. 14. When fired by percussion, the percussion cap *r* is not

struck directly by the firing pin, but the point of the pin forces in the head of the cup *t* and this, in turn, advances plug *s*. The electric ignition is effected through the brass cup *t* to which one end of the platinum wire *u* is soldered. A small quantity of guncotton surrounds this wire. Electric contact is made with cup *t* by the insulated firing pin of the gun. This cup is insulated from the body of the primer by the cylinder *w* and bushing *v*, both of which are made of vulcanite. The brass contact bushing *y* to which the other end of the platinum wire is soldered completes the electrical connection.

CHAPTER II

EXPLOSIVES, DETONATORS AND FULMINATES

REFERENCE to Fig. 3 will show that a high-explosive shell of the fixed-ammunition type comprises four principal parts; namely, the projectile, fuse (detonating), cartridge case, and primer. The projectile carries the high-explosive that, when detonated, produces such a powerful shattering effect that the steel shell is blown into atoms. The high-explosive in the shell is detonated by other very powerful explosives contained in the gaine of the detonating fuse. In the fuse proper, as many as four classes of explosives are used; namely, fulminate of mercury, black powder, picric acid, and compounds of a similar nature so combined as to make their explosive effect of different strengths. The cartridge case carries a propellant, usually nitrocellulose or nitroglycerine, that is put up in the form of flakes, long tubes, perforated grains, or flat strips. It also contains one or two charges of common black powder. One charge is located between the smokeless powder and the projectile; the other is located next to the primer pocket and assists the priming charge in effecting complete combustion of the propelling charge. The primer usually contains two explosive agents; namely, fulminates or chlorates, and black powder.

Classification of Explosives. — The explosives used in high-explosive shells, cartridge cases, fuses, and primers, may be divided into three general classes: Progressing or propelling explosives, known as "low explosives"; detonating or disruptive explosives, known as "high-explosives"; and detonators, known as "fulminates" or "chlorates." The first of these includes black gunpowder, smokeless powder, and black blasting powder; the second, dynamite, nitroglycerine, guncotton, etc.; the third, fulminates and chlor-

ates. In all classes of explosives, the effect of the explosion is dependent on the quantity of gas and heat developed per unit of weight, the volume of the explosion, the rapidity of reaction, and the character of the confinement, if any, in which the explosive charge is placed.

Black Gunpowder. — The most common of all explosives is black gunpowder. The earliest known use of gunpowder was in the sixteenth century, at which time it was used in the form of fine powder or dust. No marked improvement was made in this explosive until 1860, when General Rodman, of the Ordnance Department of the United States Army, discovered the principle of progressive combustion; this consisted in using larger grains of greater density so that the rate of combustion could be more uniformly controlled. The increased density diminished the rate of combustion, so that black powder in this form developed less gas in the first instant of combustion and the volume of gas increased as the projectile moved through the bore of the gun. Black gunpowder is usually made up of a mechanical mixture of niter, charcoal, and sulphur in the proportions of 70 parts niter, 15 charcoal, and 10 sulphur. The niter furnishes the oxygen to burn the charcoal and sulphur, the charcoal furnishes the carbon, and the sulphur gives density of grain to the powder and lowers its point of ignition.

The manufacture of black gunpowder is comparatively simple. The ingredients are ground and pulverized, after which the correct proportions of each ingredient are intimately mixed in an incorporating mill consisting of two heavy iron wheels mounted to run in a circular bed; the product is called a "mill cake." The mill cake is then subjected to pressure in a hydraulic press and forms what is known as a "press-cake." The cake from the press is broken up into grains by passing through rollers and the grains are graded by passing through sieves. The grains are glazed by rotating in drums with or without graphite, which gives a uniform density to the surface. When special forms are to be given to the powder, dies are used to obtain the desired shape; this is done after the powder has been thoroughly mixed and formed into press-cake.

Black powder or gunpowder is used in primers, fuses, and also in the cartridge case as an additional priming charge for completing the combustion of the propelling charge. In the early use of high-explosive shells, black gunpowder was also used as a bursting charge, but in recent years this has been supplemented by other and more powerful high-explosives.

Smokeless Powder. — The modern smokeless powders are put up into many forms, but all have the same base, namely guncotton. The invention of guncotton is credited to a German chemist Schoenbein, who, in 1846, discovered a substance that he called "cotton powder." Improvements were later made in the manufacture of guncotton by General Von Lenk and Sir Frederick Abel. Two of the principal smokeless powders are nitrocellulose and nitroglycerine. While the base of these is guncotton, the final stages in their manufacture are different; for instance, in the manufacture of nitroglycerine, a mineral jelly is added.

Manufacture of Guncotton. — In the manufacture of guncotton, the short fiber of the cotton that is detached from the cotton seed rather late in the process of removal is used. After being bleached and purified, this is run through a picker which opens up the fiber and breaks up any lumps; it is then thoroughly dried, when it is ready for nitration. The most generally used method of nitration consists in putting the cotton into a large vessel nearly filled with a mixture of nitric and sulphuric acid. The sulphuric acid is used to absorb the water developed in the process of nitration, which would otherwise dilute the nitric acid too much. After a few minutes immersion, the pot is rapidly rotated by machinery and the acid permitted to escape. In the process of nitration, the cotton has not changed its appearance, but has become a little harsh to touch. The nitrated product is then washed in a preliminary way, removed from the nitrator, and repeatedly washed and boiled to remove all traces of free acid. The keeping qualities of smokeless powder are dependent on the thoroughness with which it is purified. At this stage of the manufacture, at least five boilings, with a change of water after each boil-

ing, covering a total of forty hours, is necessary. Following this preliminary purification, the cotton is cut into still shorter lengths by being repeatedly run between cylinders carrying revolving knives. This operation is necessary, as

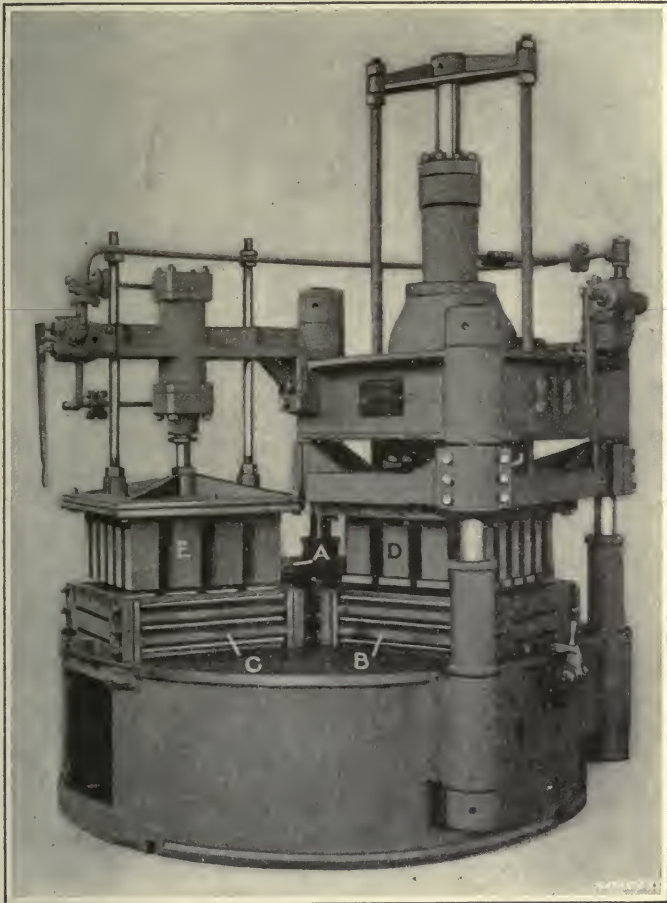

Fig. 16. Boomer & Boschert Guncotton Press

the cotton fibers are tubes, making it difficult to remove the traces of acid from the interior unless they are of very short lengths. After being pulped, the cotton is given six more boilings with a change of water after each, followed by ten

cold-water washings. The completed material is then known as guncotton or pyrocellulose.

Before adding the solvent (acetone), the guncotton must be completely freed from water. This is partly accomplished in a centrifugal wringer, but is completed by compressing the guncotton into a solid block and forcing alcohol through the compressed mass. To convert the guncotton, or pyrocellulose, into nitrocellulose, ether is added to the pyrocellulose thus impregnated with alcohol, the relative proportions being about two parts of ether to one part of alcohol, by volume. After the ether has been thoroughly incorporated in a kneading machine, the material is compressed into blocks. This is generally accomplished in a hydraulic press; a machine especially designed for this purpose is shown in Fig. 16. This press is built by the Canadian Boomer & Boschert Press Co., Ltd., and is capable of exerting a pressure of 150 tons on the material. It has three sets of dies, *A*, *B*, and *C*, which are held on a separate column on the press upon which they revolve; also two sets of punches or male dies, one set *D* being used for pressing the cotton and the other set *E* for ejecting it after pressing. The base of the machine is of cast iron, through which a number of small holes are drilled to allow drainage of the water from the cotton. The chief advantage of this press is that, being provided with three sets of dies, it is possible to load one set of dies while another is being pressed, and from the third, the cotton is ejected, thereby making the operation practically continuous. This press is operated by a pump giving a pressure of 1500 pounds per square inch.

The size of the compressed blocks varies; in some cases, these blocks are made 10 inches in diameter by 15 inches long, or are made of square section. In this operation, the pyrocellulose loses the appearance of cotton and takes on a dense horny appearance, forming what is known as a colloid. The colloid is then transferred to a finishing press where it is again forced through dies and comes out in the form of long strips or rods, which are cut into grains of the required length. The grains are subjected to a drying process, which removes nearly all the solvent (acetone) and

leaves the powder in a suitable condition for use. The drying process is a lengthy one, taking as much as four or five months for the larger grain powders. Upon completion, the powder is blended and packed in air-tight boxes.

Cordite. — Cordite is the form in which smokeless powder is used by the English government and is composed of 58 per cent nitroglycerine, 37 per cent guncotton, and 5 per cent vaseline. The vaseline renders the powder waterproof and improves its keeping qualities. For use in cannon, cordite is made into long thick rods that are tubular in form or in the form of perforated cylinders; for heavy guns, a powder called cordite M. D. has lately been introduced; this composition consists of 30 parts nitroglycerine, 65 parts guncotton, and 5 parts vaseline. The reduction in

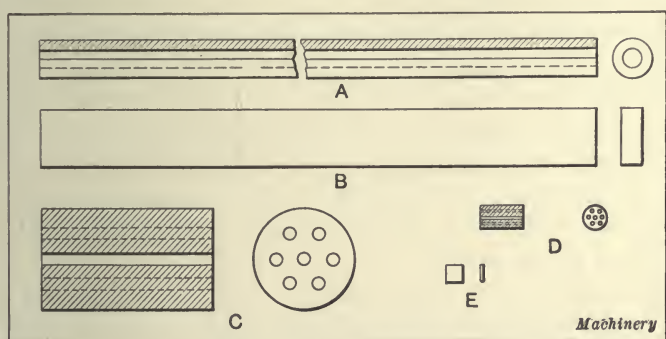

Fig. 17. Form and Size of Grain for Smokeless Powders

the percentage of nitroglycerine was necessary because of the desire to lower the temperature of the explosive and the consequent erosion in the bore of the gun.

Forms of Smokeless-powder Grains.— The form of grain in which smokeless powder is made differs in various countries. In foreign countries, especially in Germany, nitrocellulose in the form of long tubes similar in shape to macaroni are used. Fig. 17 shows a few of the many forms in which smokeless powder is put up. A shows a tube, which is sometimes two feet long; usually, however, the nitrocellulose when put up in this form is about the length of the chamber in the gun or long enough to about fill the

cartridge case. Another way in which nitroglycerine smokeless powder is put up is the slab form shown at *B*. In cartridges used by the French government, this slab is 0.0195 inch thick, $\frac{1}{2}$ inch wide, and about from 5 to 6 inches long. This form of smokeless powder is also used by the Italian government. In the United States Army service, the nitrocellulose powder is put up in the form of cylindrical grains, as shown at *C* and *D*, which are provided with seven longitudinal perforations, one central and the other six equally distributed midway between the center of the grain and its circumference. A uniform thickness of web is thus obtained. The length and diameter of the grain vary in powders for different guns, the size increasing with the caliber of the gun. The length is unimportant, the web between the perforations being the factor that receives first attention. For the 3-inch rifle, the grain has a length of about $\frac{3}{8}$ inch and a diameter of 0.195 inch, as shown at *D*. For the 12-inch rifle, the length is $1\frac{1}{2}$ inch and the diameter $\frac{7}{8}$ inch, as shown at *C*. For smaller guns, the grains are in the form of thin flat squares, as shown at *E*. When used in howitzers or mortars, smokeless powder is put up sometimes in the form of tubes, solid and tubular rods, flat disks, and rolled sheets.

High-explosives or Shell Fillers. — High-explosives, which are generally termed "shell fillers," are known by various trade-names; such as emmensite, lyddite, melenite, maximite, nitrobenzole, nitronaphthaline, shimose, trinitrotoluol, etc. The base of such explosives as emmensite, maximite, lyddite, melenite and shimose is picric acid, which is secured from coal tar subjected to fractional distillation. The liquid that comes off when this is raised to a temperature of 302 degrees F. (150 degrees C.) is called "light" oil, and when these light oils have been again distilled, the next fraction or "middle" oil is phenol or carboic acid; this substance when nitrated gives off picric acid, or, as it is sometimes called, trinitrophenol. As a shell filler, this explosive may be pressed into the explosive cavity or melted and poured in. It forms an unstable metallic salt when coming in contact with the body of the shell, and, conse-

quently, when assembling or when pouring the melted acid in the shell, it is necessary to first coat the cavity thoroughly with a non-metallic paint. Picric acid is the basis of many of the foreign shell fillers. The difference in composition of these various explosives usually consists in the addition of an ingredient (camphor, nitronaphthaline, trinitrotoluene, etc.) which are introduced to reduce the melting point.

At present, the most popular or generally used shell filler is T. N. T. (trinitrotoluol). Although the explosive force of trinitrotoluol is somewhat less than that of picric acid, the pressure of the latter being about 135,820 pounds per square inch, as against 119,000 pounds for trinitrotoluol, its advantages more than compensate for the difference. Trinitrotoluol is obtained by the nitration of toluene obtained from crude benzol distilled from coal tar and washed out from coal gas. The crude benzol contains roughly:

Constituent	Per Cent
Benzine	50
Toluene	36
Xylene	11
Other Substances	3

Toluene, to be used for the manufacture of trinitrotoluol, should be a clear water-like liquid, free from suspended solid matter, and having a specific gravity not less than 0.868 nor more than 0.870, at about 59 degrees F. (15.5 degrees C.). Trinitrotoluol, when pure, has no odor and is a yellowish crystalline powder which darkens slightly with age. It cannot be exploded by flame or strong percussion and a rifle bullet may be fired through it without any effect. When heated to 356 degrees F. (180 degrees C.), it ignites and burns with a heavy black smoke; but when detonated by a fulminate-of-mercury detonator, it explodes with great force, giving off a black smoke. Shells containing this explosive first used on the Western battlefront were given such names as "coal-boxes," "Jack Johnson," "Black Maria's," etc., by the Allies.

In the United States service, picric acid, explosive "D," and trinitrotoluol are used as shell fillers. High-explosive shells containing explosive "D" with a small charge of picric acid surrounding the detonator are used, and in high-explosive shrapnel, trinitrotoluol is used as a matrix. Trinitrotoluol may also be detonated with a fulminate-of-mercury detonator augmented by a small amount of trinitrotoluol in loose crystals.

The Russians and Austrians use a high-explosive known as ammonal, in which from 12 to 15 per cent of trinitrotoluol is mixed with an oxidizing compound, ammonium nitrate, a small amount of aluminum powder and a trace of charcoal. This high-explosive gives somewhat better results than plain trinitrotoluol, but has the one disadvantage of easily collecting moisture, and must be made up in air-tight cartridges. The British are now using an improved compound of this character, which is so prepared that trouble is not experienced with the collection of moisture.

Fulminates and Chlorates.—The action of fulminates is more powerful than either the low- or high-explosives described. They can be readily detonated by slight shock or by the application of heat and are used in primers for setting off the propelling charge in the cartridge case, and in fuses, either of the plain percussion or combination time and percussion types. The most common fulminate is made by dissolving mercury in strong nitric acid and then pouring the solution into alcohol. After an apparently violent reaction, a mass of fine, gray crystals of fulminate of mercury is produced. The crystalline powder thus produced is washed with water to free it from acid, and is then mixed with glass ground to a fine powder. Because of its extreme sensitiveness to heat produced by the slightest friction, it is usually kept in water or alcohol until needed.

A common mixture of fulminate of mercury for use in primers contains the following ingredients:

Ingredients	Per Cent
Fulminate of Mercury.....	50
Chlorate of Potassium.....	20
Glass (ground).....	30

The ground glass must be sifted through a sieve having 100 meshes to the linear inch. To the mixture given is added 0.25 per cent of tragacanth gum and a trace of gum arabic. This composition is placed in the primer while moist; after compression, the primer cap is dried for ten days at a temperature of 88 degrees F. (about 31 degrees C.), and for twelve days at 111 degrees F. (about 44 degrees C.). Then the exterior surface of the parchment covering the mixture is coated with a thick varnish composed of 0.891 gallon of 95 per cent alcohol, 2.75 pounds of shellac, and 0.5 pound resin. The varnished primers are dried at a room temperature for five or six days.

In primers used in British, American, and some of the foreign cartridge cases, the fulminate-of-mercury detonator is replaced by chlorate of potassium. The resulting composition is less dangerous to handle than when fulminate of mercury is used, and also has much less erosive effect on the bore of the gun.

CHAPTER III

FORGING HIGH-EXPLOSIVE SHELLS

At present, the preliminary stages in the manufacture of high-explosive shell forgings are carried on in one of two ways: The first is to use hot-drawn bar stock cut up into billets of the required length in cutting-off or shearing machines; the second is to cast billets, varying in length and diameter, depending on the size of the shell. These billets are then cut up into blanks of the required lengths for forging.

In one of the prominent Canadian plants engaged in this work, billets for British 4.5 high-explosive shells are cast in ingot molds to 33 inches in length by $4 \frac{15}{16}$ inches in diameter. Following the casting, the billets are thrown down into the sand and allowed to cool off. Next, the billets are cut into sections $9\frac{1}{2}$ inches long, the bar being partly severed at the required points and then taken out of the lathe and broken. The teats are finally cut off on a planer, leaving the blanks in a suitable condition for forging. When the forgings are made from bar stock, cut off from hot-rolled bars, the high-power cutting-off machine is generally used.

Forging British 4.5 High-explosive Shell Blanks. — Several methods have been used in the Canadian plants in forging high-explosive shell blanks. One prominent concern, in the early stages of this work, adopted the method shown in Fig. 18 for forging 4.5 high-explosive shell blanks. A blank $4 \frac{13}{16}$ inches in diameter by 9 inches long was heated in a furnace to 1950 degrees F. (about 1070 degrees C.) for about 45 minutes and then taken out and dropped into the die *a* shown at *A*, Fig. 18. One operator then quickly placed the guide *b* over the die and put in the punch

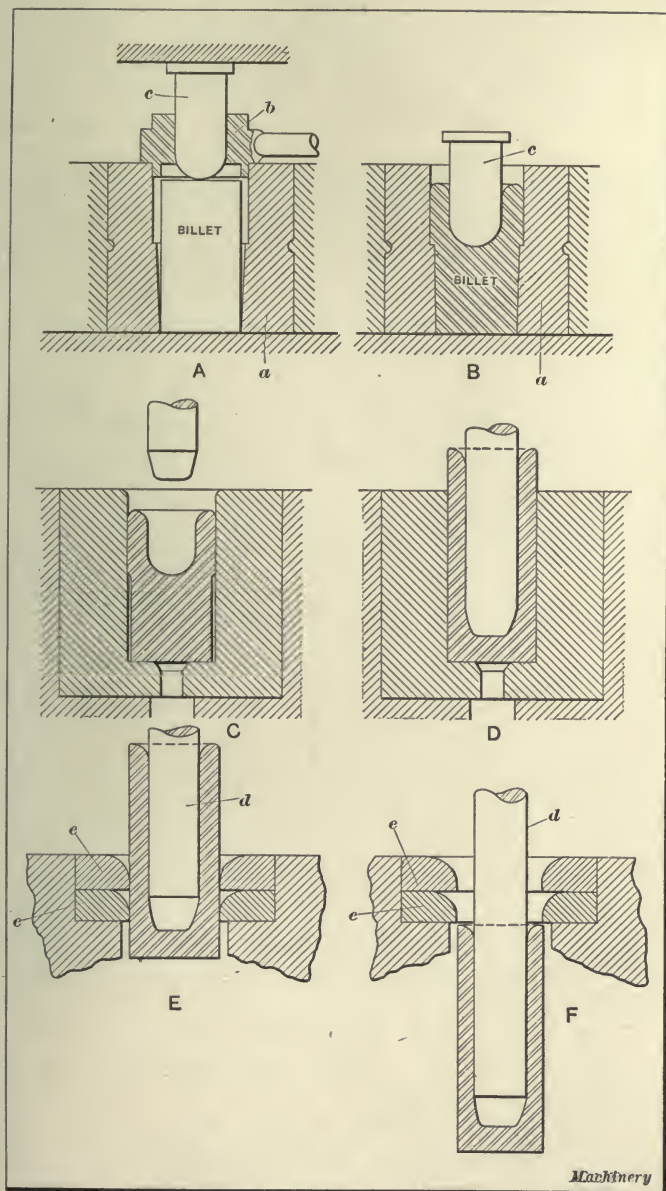

Fig. 18. Three-operation Method of making 4.5 British High-explosive Shell Forgings

c, which a steam hammer started into the billet. When the punch had been driven in far enough to get a good start, it was removed, cooled in water, the guide *b* removed, the punch replaced, and three or four blows delivered, finishing the billet as shown at *B*. The billet was again heated to the correct temperature, placed in the die, as shown at *C*, and drawn up to the shape shown at *D* by one stroke of a hydraulic press of 500 tons' capacity. A final forging or drawing operation was then accomplished by forcing the

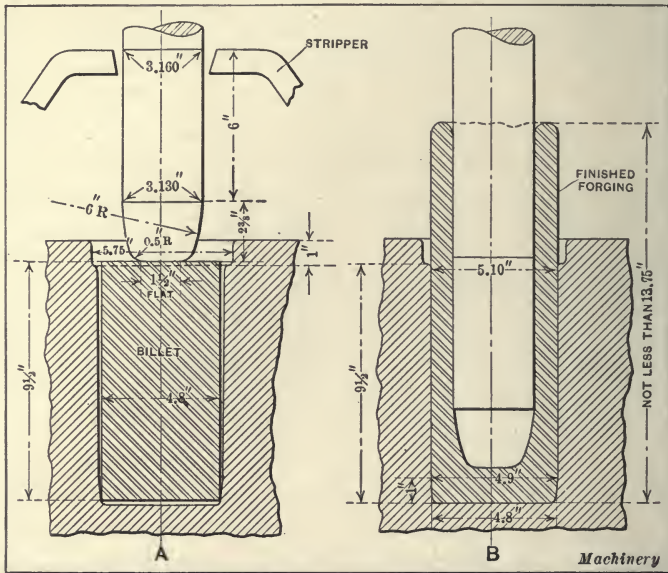

Fig. 19. One-operation Method of making 4.5 British High-explosive Shell Forgings

forging through two dies that are $5 \frac{1}{16}$ and $4 \frac{15}{16}$ inches in diameter, respectively, as shown at *E* and *F*. The forging as completed was $4 \frac{7}{8}$ inches in diameter, by $12 \frac{3}{4}$ inches long, with a base $1 \frac{1}{2}$ inch thick. After the forgings were removed from the die, they were allowed to cool, after which they were inspected.

Later Method of Forging British Shell Blanks.—The method just described has been improved by the concern using it; the new method is illustrated in Figs. 19 and 20. In Fig. 20 is shown the 350-ton hydraulic press used to

complete the forging in one "shot." The billet, as shown in Fig. 19, is 4.8 inches in diameter and 91½ inches long. This is cut off from a cast billet and placed in a furnace heated by fuel oil until it reaches a temperature of about from 1900 to 1950 degrees F. (about from 1040 to 1070 degrees C.). It

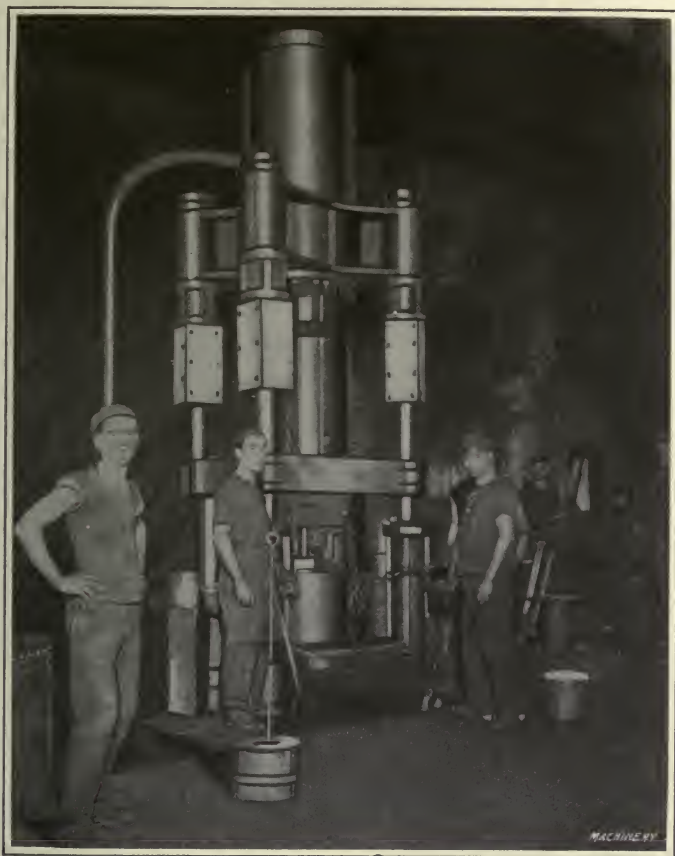

Fig. 20. Forging British 4.5 High-explosive Shells in One Operation

is then pulled out by a long bar with a bent end, dropped on to a sheet-iron slide, and carried over near the hydraulic press. Here it is quickly picked up by one of the operators and placed on a block, where all the excessive scale is removed by means of a scoop. It is then dropped into the

die and the press operated. In this particular case, no bushing or guide is used to center the punch, which is allowed to descend freely into the heated billet, extruding it around the punch. The punch and die are kept lubricated with a mixture of graphite and oil and are also cooled by a stream of water after each billet has been pierced. In this operation, the forging is drawn out in one "shot" from $9\frac{1}{2}$ to $13\frac{3}{4}$ inches in length; sometimes it even exceeds 14 inches. The shape of the die and the size and shape of the finished forging are shown at *B*, Fig. 19. The production on this operation is 220 in eight hours, and four

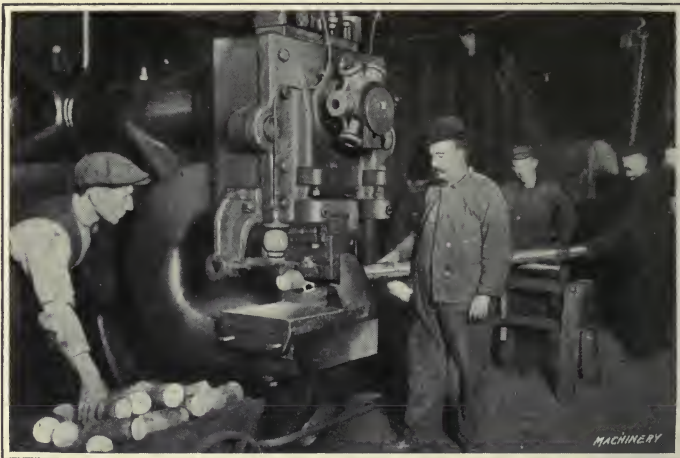

Fig. 21. Cutting off Blanks for Russian 3-inch High-explosive Shell Forgings in a Shearing Press

men are required, three to attend to the press and one to the furnace.

Forging Russian 3-inch High-explosive Shell Blanks.— A very complete and interesting forging equipment is used by the Laconia Car Co., Laconia, N. H., for turning out 3-inch Russian shrapnel forgings at the rate of 3000 per day. In this plant, the bulldozer is used for performing both the piercing and drawing operations on the forgings. Russian high-explosive shell forgings are made from steel containing 50-point carbon and are also high in manganese. Great difficulty has been experienced in cutting these bars

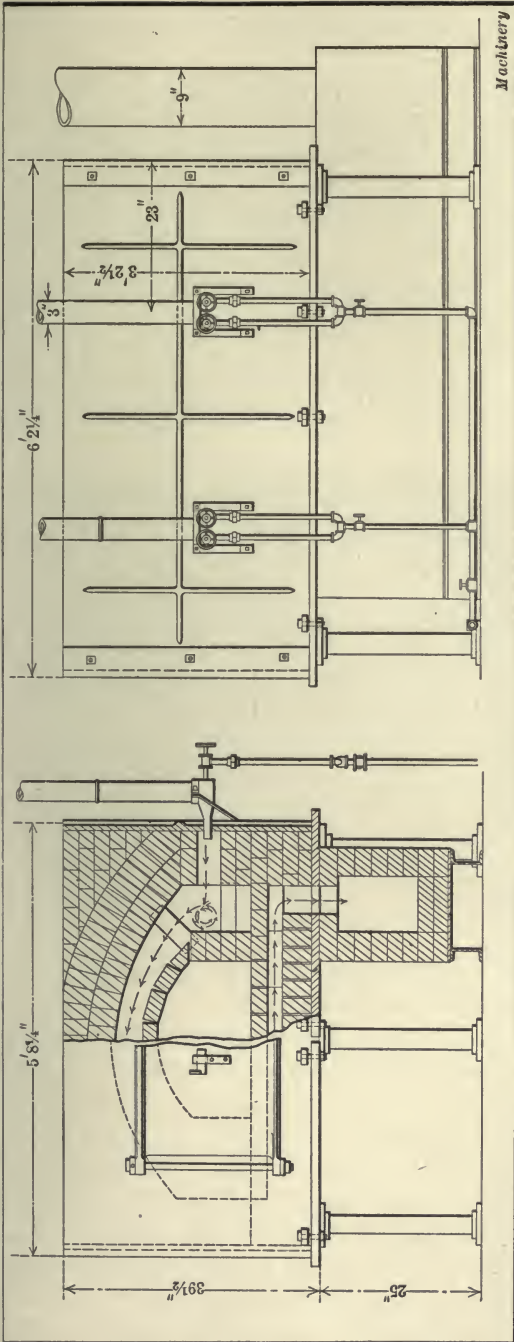

Fig. 22. Furnace built by the Laconia Car Co., for heating High-explosive Shell Blanks for Forging

with cold saws, so the Laconia Car Co. has employed with success a Cleveland Punch & Shear Co.'s shear, shown in Fig. 21. This machine is provided with cutting-off blades made from special shear-blade steel, which are formed to the shape of

the bar; about 3000 pieces are cut off between the grindings of the shear blade. The bars are about 20 feet long and $3\frac{1}{4}$ inches in diameter, and the billets are cut off to $6\frac{3}{4}$ inches in length. The machine makes about five strokes per minute.

After cutting off, the billets are placed in a furnace of the type shown in Fig. 22, which has been built especially for this work by this company; here the blanks are heated to 2250 degrees F. (about 1230 degrees C.). These furnaces are of the open-hearth down-draft type, built to the dimensions given in the illustration. The heating space is 18 inches at the highest point of the arc, and 3 feet wide by 5 feet 6 inches long. Each furnace is provided with two double burners, and $\frac{1}{2}$ -pound air pressure from a Sturtevant fan is sufficient to operate them. In maintaining a temperature of 2250 degrees F., only 9 gallons of crude oil

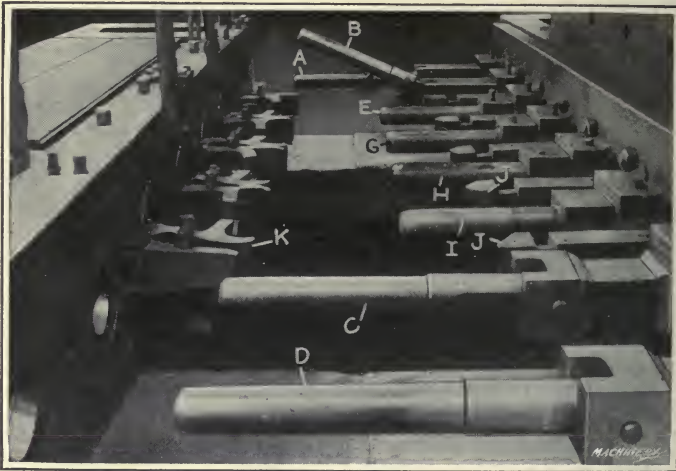

Fig. 23. Arrangement of Dies and Punches on Williams & White Bulldozer for forging Russian High-explosive Shells

is consumed per hour by each furnace. With these furnaces, a temperature of 2850 degrees F. (about 1570 degrees C.) can be obtained without trouble, but the temperature required for this work seldom exceeds 2300 degrees F. (about 1260 degrees C.).

Forging Machine.—The forging is done on a Williams & White size 9-U bulldozer, as shown in Fig. 23. This machine is capable of making six strokes per minute and a forging is completed in two strokes; the piercing and drawing operations are carried on at the same time. The piercing punches and dies shape the piece, as shown at B, Fig.

24, whereas the drawing punches and dies complete the forging as shown at *C*. The piercing and drawing dies are held in a special holder fastened to the bed, whereas the punches are held on the cross-head. The two outer punches at each side, *A*, *B*, *C*, and *D* are the drawing punches, and the four inner ones *E*, *G*, *H*, and *I* are for piercing. There are seven men in the forging team for each machine: One attends to the furnace, one removes the forgings from the furnace, and one starts and stops the bulldozer and looks after the machine; on each side of the machine there are two tool-men and two forgers.

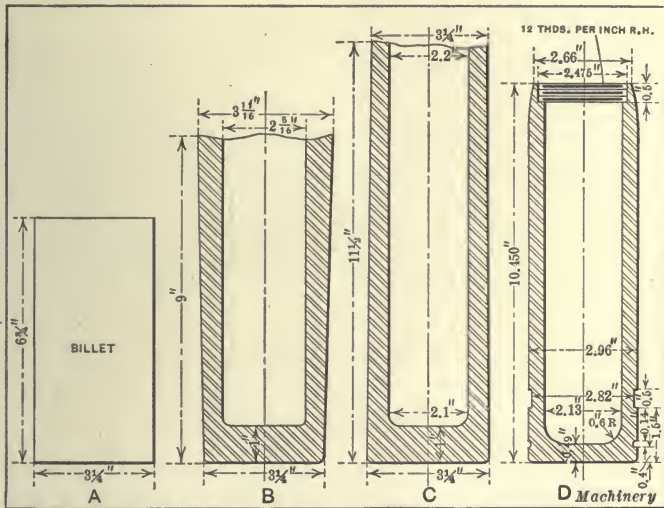

Fig. 24. Russian 3-inch High-explosive Shell from the Blank to the Finished Shell

The method of operation is as follows: The forge-man gets the hot billet from the furnace-man and puts it in one of the two piercing dies on his side of the machine; one blow partly forms it. He then passes it on to one of the two drawing punches at his side, the tool-man swinging the punch up to permit the forging to be removed and at the same time greases the punch. The object of having two piercing and two drawing punches is to allow one to cool while the other is being used, the two sides of the machine being used alternately.

Fig. 23 shows clearly how the punches and dies are held. The piercing punches are shorter than the drawing punches and pass through the strippers *K*, which remove the pierced forging from the punch, as the forging is not forced through the die when being pierced. The strippers are operated by the V-shaped members *J*, which come between them and close them in on the punch.

The piercing punches are made from special vanadium steel, and 5000 forgings are made before the punches are worn out. The drawing punches are also made from vana-

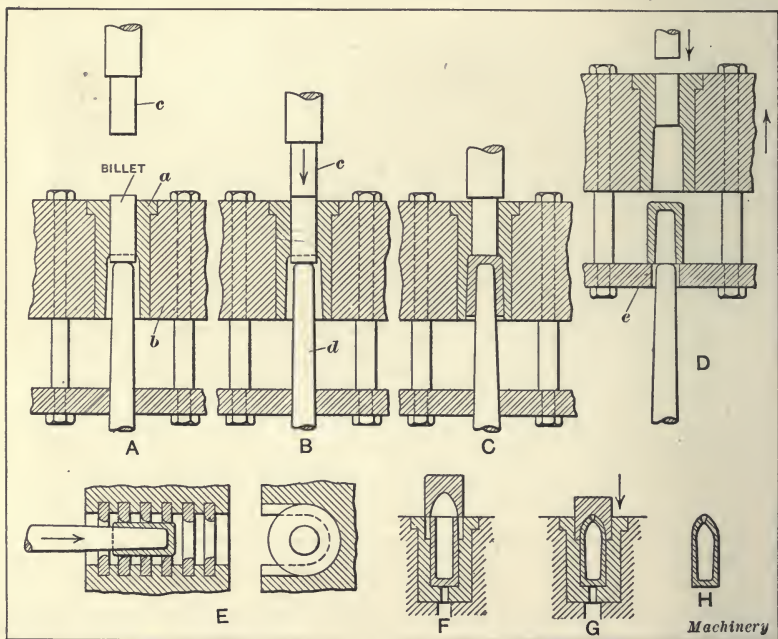

Fig. 25. Method of Forging Large-caliber High-explosive Shells

dium steel and turn out about 3000 blanks before giving out. For the dies, white cast iron is used, and 4000 blanks is the limit obtained from one die. The drawing dies are made of chilled cast iron and last from 1800 to 2000 forgings. The forgings are not annealed, but are allowed to cool slowly in sand. One team of men and one machine will produce 500 forgings in eight hours without any trouble.

Forging Large-caliber Shell Blanks.— At present, there are two principal methods of making large high-explosive shell blanks. One of these does not differ materially from that used in the production of forgings for medium-caliber shells. In the large-caliber shells, the hole in the nose, when the shell carries a nose fuse, is small in proportion to that used in the small-caliber forgings. Consequently, a greater amount of metal is turned in at the nose.

One method of making these shells is shown in Fig. 25.

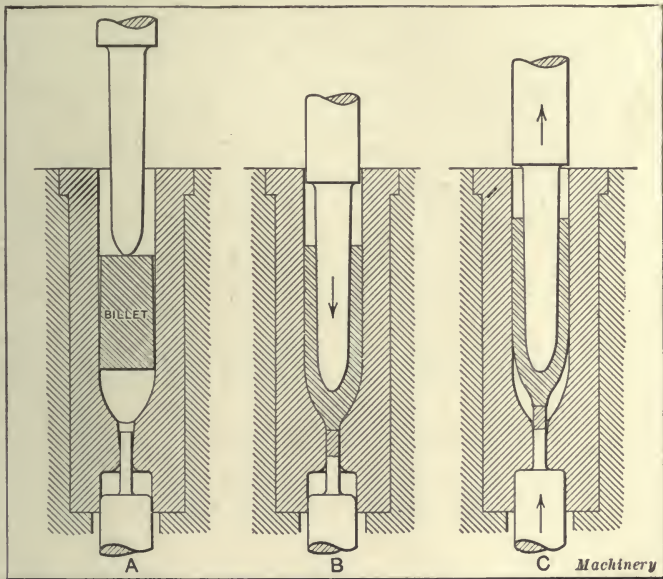

Fig. 26. Diagram Illustrating Method of Forging Armor-piercing Shells

The preliminary stages in the process, shown by the diagram at A, B, C, D, and E, are the same as for making an ordinary forging. For instance, the billet is pierced, as shown at A, B, and C, by being forced over punch *d* by punch *c* acting through die *a*. The frame carrying die-holder *b* then rises, and stripper plate *e* removes the pierced forging from the punch, as shown at D. The next step consists in drawing the pierced forging through dies, as shown at E. The forging is then heated on the nose end,

taken to another press and dropped into a die, as illustrated at *F*. The nosing-in punch then descends, as shown at *G*, and closes in the open end of the forging to the shape shown at *H*. Further operations consist in drilling out the nose for the fuse, and threading it, etc., for the reception of the fuse. In this class of forging, no machining whatever is done in the cavity of the shell.

A method of making large-caliber shell forgings that are open both on the nose and the base ends is to use seamless drawn tubing. The operation consists in cutting a piece of tubing to the required length, heating one end, and placing the tubing in a hydraulic press, where, by means of a properly shaped die and punch, the base end is upset in toward the center. The forging is then heated on the opposite end, placed in another press, and nosed-in in a manner similar to that shown at *G*, Fig. 25. This method of making large forgings has the advantage of saving considerable material, both in the preliminary stages and in the final machining operations.

Forging Armor-piercing Shells.—Armor-piercing shells are always made with a solid nose, as this type of shell is used for piercing hardened armor, which calls for great strength in the nose. One method of making armor-piercing shells, which is also applicable to the production of the type of high-explosive shell used by the United States government, is shown in Fig. 26. This method does not differ in principle from that shown in Fig. 19, except that the shell is forged with the nose instead of the base down. Usually, the punch is not relied upon to center in the billet accurately, so a centering bushing is used. The bushing is inserted in the top of the die, the punch is allowed to descend for a short distance into the heated billet and is then raised; the bushing is then removed and the punch again advanced. When making a forging in the manner shown in Fig. 26, it is usually necessary to eject the forging and make it follow the punch, from which it is removed by a stripper as the punch rises.

CHAPTER IV

MACHINING BRITISH 18-POUND SHELLS

A VARIETY of methods are used in machining the British 18-pound (3.29-inch) high-explosive shell shown in Fig. 27. In the greater number of cases, however, the shell is machined from bar stock. One of the two principal methods used in machining from bar stock, outlined in Table I, consists in cutting up bars of hot-drawn stock into billet lengths, which are then drilled and reamed, and afterwards turned, etc. The other, while similar in the final operations, starts with turning. A bar generally sixteen feet

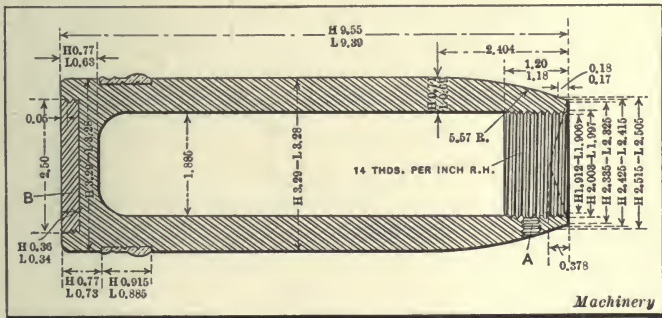

Fig. 27. British 18-pound High-explosive Shell

long is centered on both ends, then put in the lathe and turned down to approximately the finished size. After this, it is cut up into shell lengths, drilled, reamed, threaded, etc.

Cutting off 18-pound Shell Blanks.— Many methods are used for cutting off shell blanks; usually, however, several blanks are cut off at one time. The Earle Gear & Machine Co. has devised a fixture for the Lea-Simplex cold saw by means of which nine bars can be cut off at one setting. The average cutting time for nine bars is nine minutes, and the production on $3\frac{1}{4}$ -inch bars is about sixty per hour.

TABLE I. ORDER OF OPERATIONS, MACHINES AND TOOLS USED, AND PRODUCTION FIGURES
ON BRITISH 18-POUND HIGH-EXPLOSIVE SHELLS

Number of Operation	Character of Operation	Machine	Tools	Feed in Inches	Speed, R. P. M.	Production Per Hour
0	Cutting Off Bar Stock (9 Bars)	Earle Gear & Machine Co.	Huther Saw	60
1	Drilling Hole	Baker Drill	"Hercules"	0.017	115	9
2	Rounding Bottom of Hole	Baker Drill	Morrow Mfg. Co.	Hand	115	30
3	Reaming Hole	Baker Drill	Morrow Mfg. Co.	0.032	115	12
4	Turning, Facing, Waving, etc.	2 A Warner & Swasey	Edgar-Allen Steel	0.041	187	6½ to 7
5	Rough-turning Nose	Reed 20-inch Lathe	Edgar-Allen Steel	0.071	56	12 to 14
6	Facing, Turning, Recess, etc.	2 A Warner & Swasey	Edgar-Allen Steel	0.028-0.058	78	15 to 17
7	Finish-turning	Reed 18-inch Lathe	Edgar-Allen Steel	0.047	100	12 to 15
8	C. Bore and Drill Screw Hole	Barnes Drill	40
9	Tapping Screw Hole	Barnes Drill	Peter Bros. Chuck	40	40
10	Face Recess in Base	Fay & Scott 16-inch Lathe	Edgar-Allen Steel	0.031	180	40
11	Threading Nose	Holden-Morgan	20
12	Recessing and Threading Base	Holden-Morgan	13
13	Washing and Inspecting
14	Screwing in Base Plug	Vise	30
15	Cutting Off Projection	Jenckes Lathe	Wrench	32
16	Riveting Gas Plug	High-Speed Hammer	Edgar-Allen Steel	Hand	180	120
17	Facing Base End	Jenckes Lathe	500 Blows	180
18	Cutting Air Grooves in Waves	Brown-Boggs Press	Edgar-Allen Steel	0.031	240
19	Pressing on Copper Band	Goldie & McCulloch Press	40
20	Finishing Copper Band	Warner & Swasey Lathe	Edgar-Allen Steel	40
21	Varnishing	Bowser Varnish Machine	Hand	120	120
22	Baking	Crawford Furnace	30
23	Cleaning, Insp. Screw in Plug
24	Stamping	Holden-Morgan Stamping Machine	60
25	Inspecting	Gages, etc.

Machinery

Drilling and Reaming. — After cutting off, the first operation, rough-drilling, is usually performed in a high-power drilling machine, as shown in Fig. 28. The shell blank is held in a special fixture, shown in Fig. 29, consisting of two jaws operated by left- and right-hand screws by means of handwheel A. The top of the fixture is of yoke form and



Fig. 28. Baker High-power Drilling Machine at Work on British 18-pound High-explosive Shells

carries the drill-guiding bushing *B*. In this particular case, the drilling is done with a "Hercules" 1 13/16-inch drill, rotated at 115 R. P. M. and fed down into the work at a feed of 0.017 inch per revolution of the drill. The hole drilled is 87/8 inches deep, and the production is nine per

hour. To start the drill central with the blank, a bushing is slipped into the top of the jig, but when the drill has once started properly this is removed. The second operation consists in rounding the bottom, that is, removing the vee left by the end of the drill. This is done with a counterboring tool rotated at 115 R. P. M. and fed down by hand. The machine used is a Baker high-power drilling

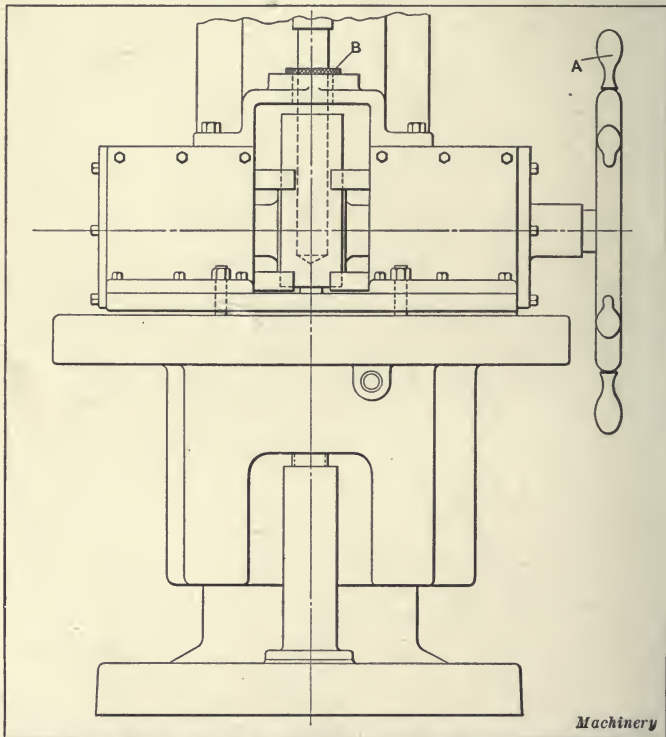

Fig. 29. Fixture used in Holding 18-pound Shell Blanks when Drilling

machine and the production is thirty per hour. The third operation consists in reaming the hole to 1.885 inch in diameter with a reamer rotated at 115 R. P. M. and fed at the rate of 0.032 inch per revolution to $8 \frac{15}{16}$ inches deep; the production is twelve per hour.

Turning Band Groove, Waving, etc. — The fourth operation is performed on a No. 2-A Warner & Swasey turret

lathe in the order shown by the diagram, Fig. 30. This consists first in rough-turning the external diameter with a box-tool *A* for a distance of about $6\frac{3}{8}$ inches from the base end and removing $\frac{1}{4}$ inch from the diameter at a feed of 0.041 inch per revolution of the work; second, boring the gas-plug recess, facing the end, and turning and forming the radius with tool *B*; third, rough-forming the band groove with tool *C*; fourth, finish-facing the plug recess and end with tool *D*; fifth, forming waves in the band

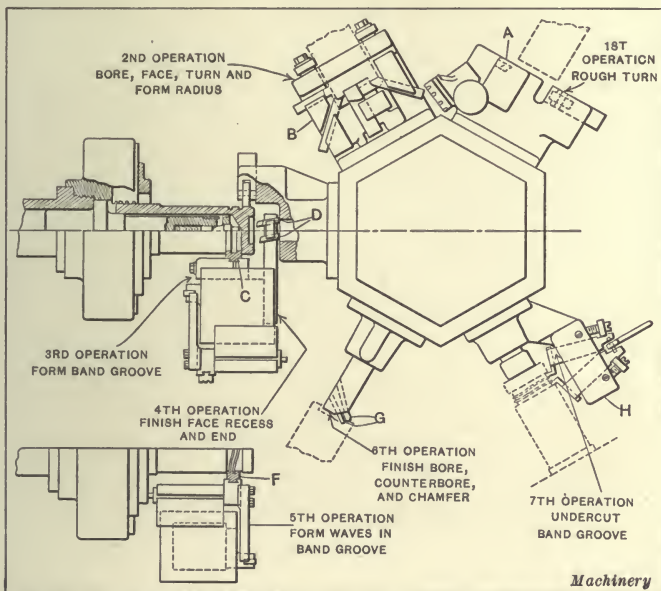

Fig. 30. Diagram showing Set-up for performing External Turning, Facing and Waving Operations

groove from the cross-slide with tool *F*; sixth, finish-boring, counterboring, and chamfering the plug recess with tool *G*; seventh, under-cutting the band groove with tool *H*. The waving is done from the cross-slide and at the same time the work is supported by a roller support from the turret. For the finishing cuts, the work is rotated at 187 R. P. M., and the production is from six and one-half to seven per hour.

Rough-turning, Facing, etc.—The fifth operation consists in rough-turning the nose in a Reed-Prentice 20-inch

engine lathe, as shown in Fig. 31, with a single tool operating at a feed of 0.071 inch per revolution, and with the work revolving at 56 R. P. M. The shell is held in a special draw-in collet *A* that is supported by a steadyrest, as shown. Three cuts are required to finish the nose of the shell to form, the tool being controlled in its movement by a cam located at the rear of the machine. The production is from twelve to fourteen per hour.

The sixth operation is performed on a No. 2-A Warner & Swasey turret lathe, as shown in Fig. 32. In this set-up the shell is rough-faced to length and the clearance angle

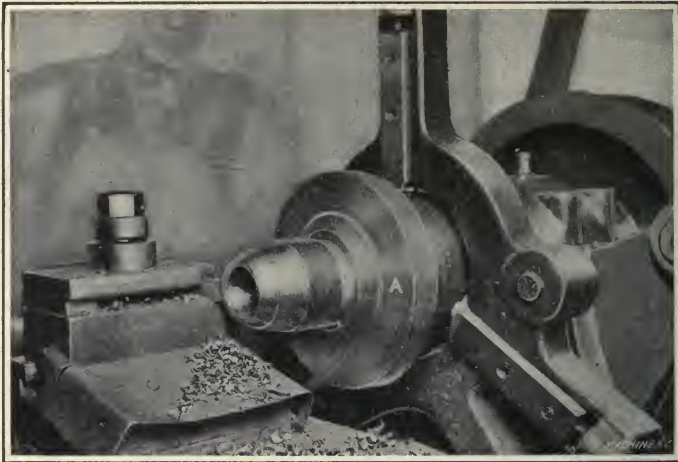

Fig. 31. Rough-turning Nose in an Engine Lathe

cut on the nose. The recess is then cut at the bottom of the thread with recessing tool *A* and the hole reamed for threading to 1.906 inch in diameter, 1.2 inch deep, with tool *B*. A light cut is taken across the radius on the nose with tool *C* which carries a roller pilot and is operated from the cross-slide. The work is rotated at 78 R. P. M. for the profiling or the radius cut at a feed of 0.058 inch per revolution. The feed is reduced to 0.028 inch per revolution for reaming. The production is fifteen to seventeen per hour.

Finish-turning.—The seventh operation consists in finish-turning from the band groove to the nose on an F. E.

Reed 18-inch engine lathe, as shown in Fig. 33. Here the cross-feed screw has been removed and the movement of the cross-slide is controlled by a former at the rear. The shell is held at the closed end by a two-jaw chuck, and lo-

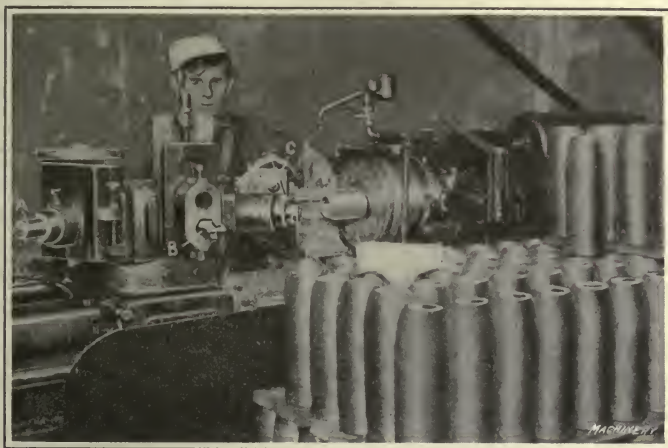

Fig. 32. Performing Sixth Operation on a 2-A Warner & Swasey Turret Lathe

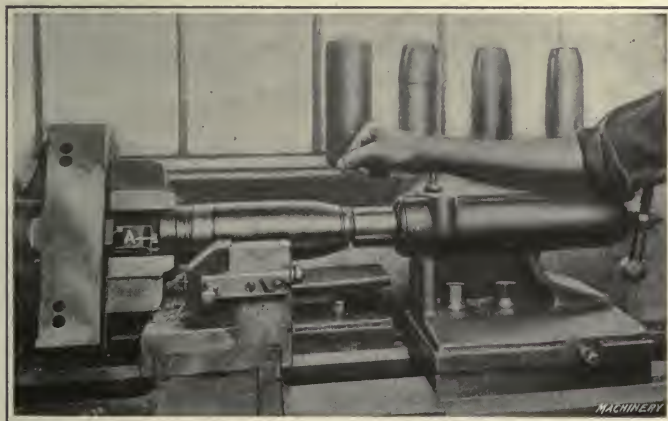

Fig. 33. Finish-turning External Diameter on an Engine Lathe

cated by a stop-screw A; a plug is screwed into the open end and is supported on the tailstock center. The work is rotated at 100 R. P. M. and the feed is $\frac{3}{64}$ inch per revolu-

tion. One man runs two machines and the production is twelve to fifteen per hour from each machine.

Counterboring, Making Screw Holes, etc. — The eighth operation is to counterbore and drill the grub-screw hole A, Fig. 27, in the nose of the shell for fastening the fuse in place. The ninth operation on the shell consists in tapping the screw hole with a Peter Bros. tap chuck held in a Barnes drill. It requires two taps to finish this hole and they are operated at 40 R. P. M.; the production is forty per hour.

The tenth operation is to face the recess in the cavity in the base end of the shell where the gas plug is to be inserted. This is performed in a Fay & Scott 16-inch engine

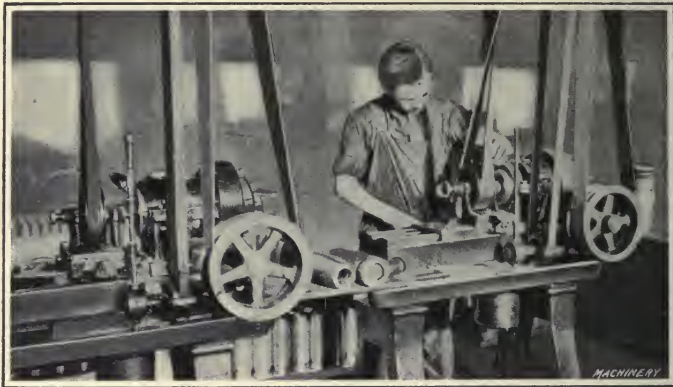

Fig. 34. Threading Nose and Base Ends of Shell in Holden-Morgan Special Thread Milling Machines

lathe, and one cut is taken with a tool held in a special holder. The tool is started at the outside of the recess and works in toward the center. The work is rotated at 180 R. P. M. and the feed is $1/32$ inch per revolution; the production is forty per hour.

Threading Nose and Base Ends. — The eleventh operation consists in threading the nose of the shell in a Holden-Morgan thread milling machine, as shown in Fig. 34. A hob similar in construction to that described in connection with Fig. 35 is used for cutting the thread, and one revolution of the work completes the thread, which requires 1.10 minute. The production is twenty per hour from each ma-

chine, one operator attending to two machines. The twelfth operation consists in recessing and threading the base end of the shell in a Holden-Morgan threading machine of the same type as those shown in Fig. 34. Here one man also runs two machines, one being set up for recessing and the other for threading. The production is 130 in ten hours from the two machines. The thirteenth operation consists in washing the shells in hot soda water, after which they are inspected.

Machining the Gas Plug.— Before any other operations are performed on the shell, the gas plug *B*, Fig. 27, is made

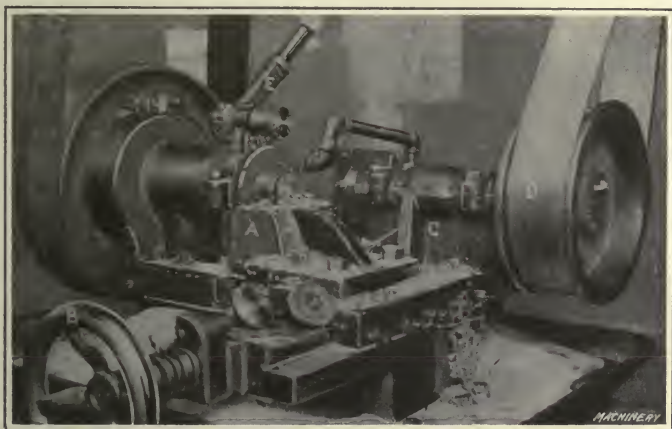

Fig. 35. Machining Gas Plugs on Holden-Morgan Special Plug Machine

from a forging and is faced, turned, and threaded on the Holden-Morgan special plug milling and threading machine shown in Fig. 35. The plug is held by the tail in a special draw-in chuck. The first operation is to rough-turn and face the end of the plug, two cuts being taken. The tools used are located one behind the other in a tool-holder *A* that is fastened to the front of the cross-slide operated by the handwheel *B*. On the rear of the same slide is a special holder *C* that carries the threading tool. This consists of a hob built up of a series of concentric disks provided with cutting teeth and held on a special arbor driven by a sep-

arate belt *D*. To cut the thread, lever *E* is pulled down, withdrawing a stop which allows the spindle to feed back into the housing. The spindle-driving mechanism is then shifted to slow speed, and the spindle moves back at the required pitch—slightly over one complete revolution of the work (which takes forty seconds) finishing the thread. The work is rotated at 200 R. P. M. for turning and facing, and the production is twenty per hour.

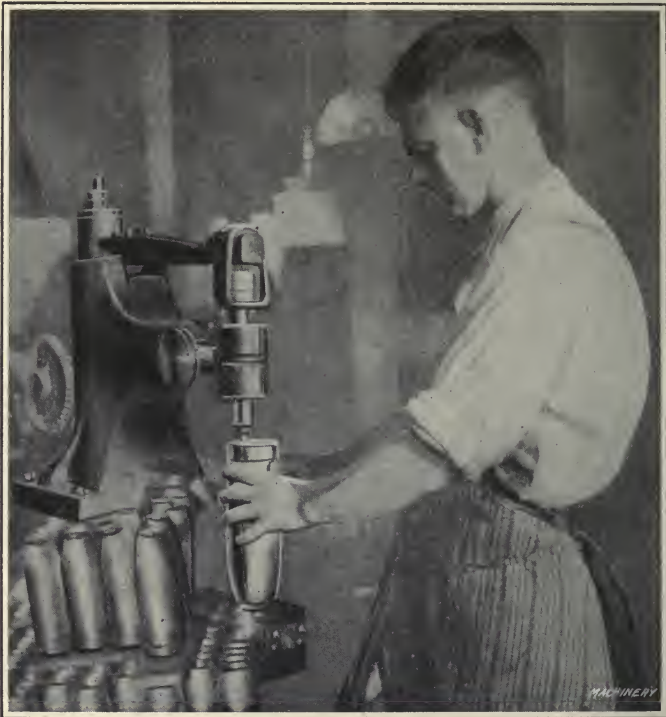

Fig. 36. Riveting in the Gas Plug In a "High-Speed" Hammer

Final Machining.— The fourteenth operation consists in screwing in the base plug, which is first coated with red lead. Two men are employed for this operation, one inserting the plug and the other screwing it in with a wrench. The production is thirty per hour. The fifteenth operation consists in hogging off the projection on the base plug in

a Jenckes lathe. First, a facing cut is taken along the plug, then the teat is cut off, and finally a finishing cut is taken. The production is thirty-two per hour, and the lathe is operated at 180 R. P. M., hand feed being used.

The sixteenth operation consists in riveting in the gas plug with a "High-Speed" hammer operating at 500 blows per minute, as shown in Fig. 36. The shell is held on an



Fig. 37. Varnishing Interior of High-explosive Shells

arbor and is spun around by the operator as the hammer descends. The production is 120 per hour. The seventeenth operation consists in facing the base in a Jenckes machine, one cut being taken at a spindle speed of 180 R. P. M. and $1/32$ inch feed per revolution of the work. The depth of cut is $3/32$ inch. The eighteenth operation is cut-

ting the air grooves in the waves in the band groove. This is accomplished in a Brown-Boggs inclinable press which carries a fixture in which the shell is located. The cuts are made with a punch, shaped like a cold-chisel, held in the ram of the press, and the production is 240 per hour. In the nineteenth operation, the copper band is pressed into the band groove in a Goldie & McCulloch hydraulic press of the six-cylinder type. Three squeezes are required to compress this band, and the production is forty per hour.



Fig. 38. Stamping in a Holden-Morgan Rotary Stamping Machine

For the twentieth operation, the shell is brought back to a Warner & Swasey brass-working lathe, where the copper band is turned to shape. The work is rotated at 120 R. P. M. and roughing and finishing cuts are taken. The roughing cut is taken from the front slide and the finishing cut from the rear. The shell is supported by means of a steadyrest. The production is forty per hour.

TABLE II. PRINCIPAL OPERATIONS ON BRITISH 18-POUND HIGH-EXPLOSIVE SHELLS WHEN MADE FROM TURNED BARS OF STOCK

Number of Operation	Character of Operation	Machines	Tools	Feed in Inches	Speed, R.P.M.	Production Per Hour
1	Sawing to Shell Lengths.....	Newton Cold Saw.....	Huthier Saw	25
2	Drill, Ream and Form.....	Barnes 22-inch Drill.....	Oil-tube Tools	0.013 to 0.093	37 to 145	3
3	Drilling and Tapping for Fixing Screw	Two-spindle Drilling Mach.	Errington Tap-Chuck	48
4	Mill Threads in Nose.....	Lees-Bradner Thread Miller	Special Hob	35
5	Drill Center in Base.....	Engine Lathe.....	Center Drill	50
6	Waving and Under-cutting.....	Engine Lathe.....	Form Tools	15
7	Weigh, Mark for Cut-off and Heat No.	Weighing Scale and Chart	Blue Chalk	40
8	Face, Bore and Under-cut Base End..	Engine Lathe.....	Turning Tools	8
9	Thread Base End.....	Lees-Bradner Thread Miller	Special Hob	40
10	Screw in Gas Plug.....	Drilling Machine.....	"Flywheel Chuck"	50
11	Face-off Gas Plug and Roll.....	Engine Lathe.....	Turning Tools	14
12	Press on Copper Band.....	West Tire Setter Co. Press	Six Press Plungers	45
13	Form Copper Band.....	Engine Lathe.....	Form Tools	Hand
14	Mark.....	Noble & Westbrook.....	Lettering Dies
15	Varnish Cavity.....	Special Fixture.....	Round Brush
16	Final Inspection.....	Special Gages

Varnishing, Stamping, and Inspecting. — The twenty-second operation is bak- ing in a Crawford sectional furnace which is built by the Oven Equipment Co., New Haven, Conn. Two hundred and forty shells are placed in this furnace, which is heated to a temperature of 300 degrees F. (about 149 degrees C.), and kept at that

temperature for eight hours. The shells are allowed to remain in the furnace for this time and then are taken out and allowed to cool off in the air. The twenty-third operation is cleaning the nose of the shell with a rag and gasoline. The shells are then ready for inspection, after which the plug is screwed into the nose end.

The twenty-fourth operation consists in stamping in the Holden-Morgan machine shown in Fig. 38. The stamp *A* is oscillated by an eccentric and crank movement, and when

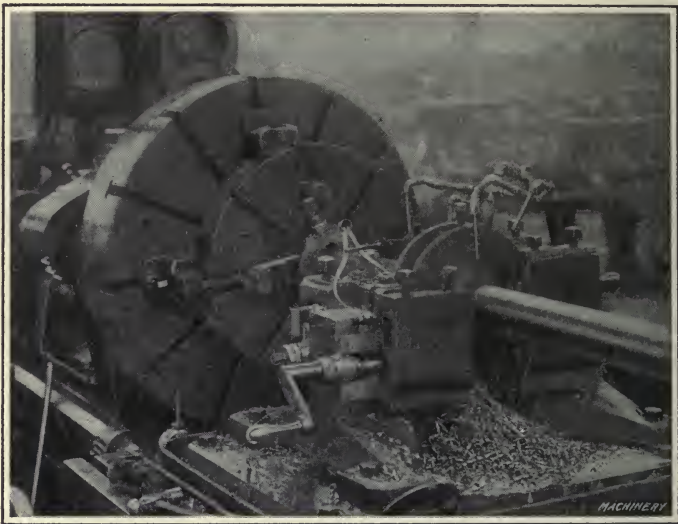

Fig. 39. Turning Long Bars from which Billets for High-explosive Shells are subsequently cut

the stamp is brought down in contact with the work by operating handwheel *B* the shell is rotated by it. The production in this operation is sixty per hour. The twenty-fifth operation is the final manufacturing and government inspection; 240 completed shells represent eight hours' work in this plant.

Alternative Method of Machining British 18-pound Shells.—A method that is not as widely practiced as that just described is outlined in Table II. By it, hot-drawn

steel bars $3\frac{1}{2}$ inches in diameter by 16 feet in length are centered in both ends, by first scribing two diametral lines across the ends of the bar and then drilling the center holes with a portable drill. The bars are next set up on centers on an engine lathe and straightened with a jack until they run fairly true. One end of the bar is then stepped down to the required diameter for a length of approximately 18 inches; the purpose of this is to form a bearing for the steadyrest, which is used during the turning operation, and also to provide a starting point for the special turning head employed. The bars are turned down to a diameter

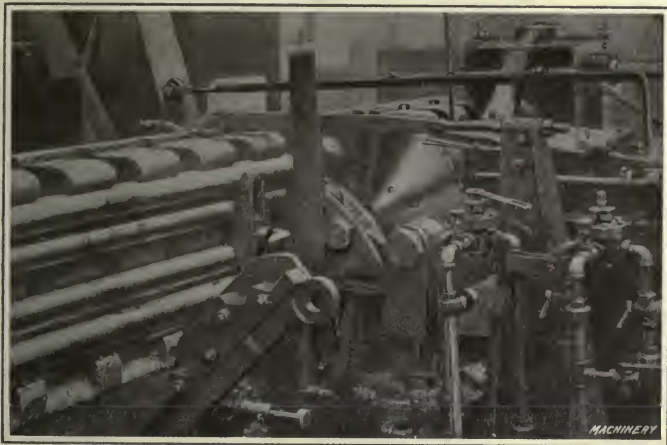

Fig. 40. Cutting Turned Bars to Shell Lengths in a Newton Cold Sawing Machine

of $3.285 \text{ inches} \pm 0.005 \text{ inch}$, and for this purpose a special traveling head, as shown in Fig. 39, is employed. This head carries five tools, three next to the chuck and two on the opposite side of the supporting bushing. The first two cutters are progressive roughing cutters, the third is a "smoothing" cutter, and the two cutters on the right-hand side of the supporting bushing take finishing cuts; the depth of the cut taken by the last finishing tool is very light. Accuracy for diameter is determined by a snap gage and a ring gage; the snap gage is used to make sure that the bar is not turned under size, whereas the ring gage follows along

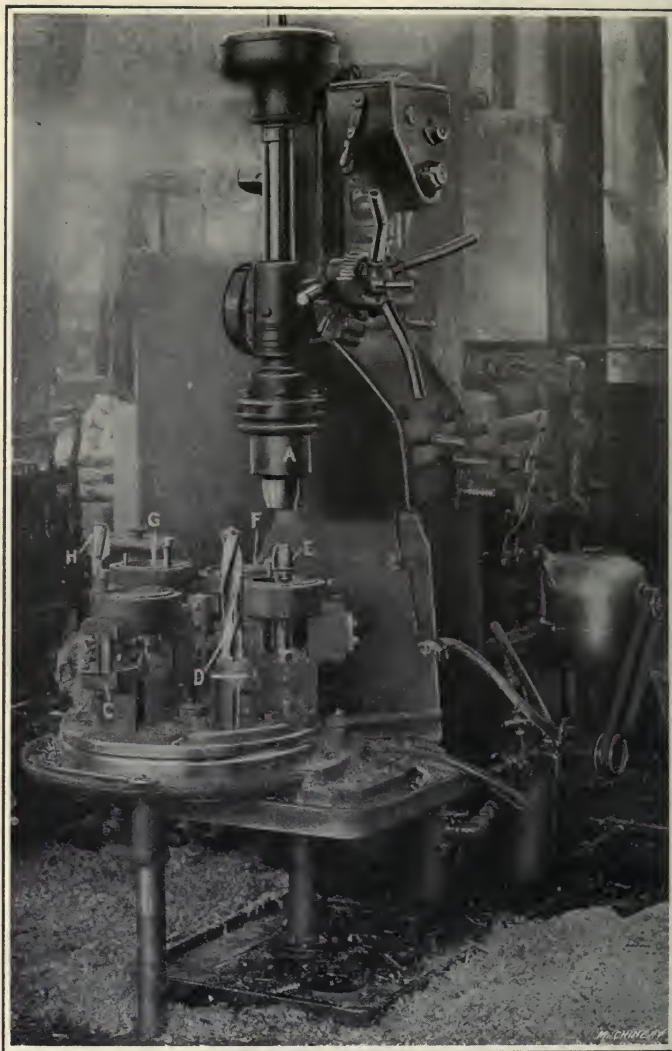

Fig. 41. Machining Hole and Nose of Shell Blank in Barnes Drilling Machine

the bar after the turning head. Should it happen that the last tool is cutting too large, the operator takes a file and touches the high spots until the ring gage will pass.

Sawing Turned Bars to Billet Lengths.—Two Newton

machines equipped with Huther inserted-tooth saw blades are used for cutting up the turned bars into shell blanks $9\frac{5}{8}$ inches in length. These machines, as shown in Fig. 40, hold four bars at a time, and are equipped with traversing work-holding fixtures that move the stock along after each successive cut has been completed, a stop being employed to control the length of the blanks. The work is held in the fixture by a special arrangement of clamps, which are



Fig. 42. Close View of Fixture shown in Fig. 41, illustrating Method of applying Tools to Work in an Inverted Position

operated by compressed-air cylinders working in conjunction with toggle-joints. In order to facilitate loading the bars into the work-holding fixture, an auxiliary rack is provided in which four bars are placed before the four bars in the work-holding fixture have been completely cut. When the final blanks have been cut from the bars, the work-holding fixture is moved back to the starting point and the

auxiliary rack—which is pivoted to the base that supports the traveling work-holding fixture—is swung up by means of a crane hoist. This brings the next four bars into position in the rack ready to be clamped.

The design of the traveling work-holding fixture is such that the bars cannot be completely cut up into blanks, the crop end of each bar having sufficient material for three shell blanks. These crop ends are cut up on another cold saw; one of the blanks produced in this way is already turned to size, while the other two blanks are cut from the rough end of the bar which was not reached by the special turning head shown in Fig. 39. These two rough crop ends are turned down to the required diameter on an engine lathe.

Drilling, Reaming, and Turning Nose. — The method used for drilling, reaming, and forming the nose of the shell differs greatly from that just described. The development of fixtures for performing this work on the upright drilling machine is unusual, so this method has largely overcome the great difficulty experienced in securing early deliveries on all forms of lathes for machining shells. Besides, by the inverted-tool method, chip trouble is largely overcome. The equipment used consists of a battery of eight, self-oiling, 22-inch, all-gear, drilling and tapping machines built by the Barnes Drill Co., and much of the credit for the development of this method of machining shells is due to the designers employed by this concern. Figs. 41 and 42 show one of these machines equipped for shell work. These show that the shell to be machined is held by a chuck on the drill spindle, whereas, the tools that perform the drilling, reaming and nose-forming operations are carried by a rotary fixture *B* supported on the table of the machine. The fixture consists of a baseplate and rotating table upon which the tool-holders are mounted. The proper indexing of the various tools is provided for by means of a taper pin in the base of the fixture engaging corresponding holes in the rotating table which is rigidly retained by a clamp. The sequence of operations is as follows:

First Operation:—Spot-drill and rough-form nose with tools held in holder *C*. For this operation the spindle ro-

tates at 92 R. P. M. with a down feed of 0.013 inch per revolution. The drilling is done by a short twist drill, and the rough-forming of the nose by three turning tools which are stepped in so that they cut to different depths, leaving an irregular surface that is finished in a subsequent operation. The shell is supported by a bronze-lined bushing so that the work is adequately supported while being machined.

Second Operation:—Drill hole in shell to required depth with a drill *D* 1 13/16 inch in diameter. For this operation the spindle is rotated at 145 R. P. M. and at a feed of 0.013 inch per revolution.

Third Operation:—Rough-ream the hole with reamer *E*, which is formed at the end to finish the bottom of the cavity to the required shape. For reaming, the spindle is operated at 37 R. P. M. with a down feed of 0.093 inch per revolution. When the reamer reaches the pointed end of the hole as left by the twist drill, the power feed is disengaged and the spindle fed down by hand until the positive stop is reached.

Fourth Operation:—Finish-form nose with form-cutter located in holder *F*, which is bronze-lined. The spindle is rotated at 45 R. P. M. and fed down by hand.

Fifth Operation:—Cut step and bevel on nose of shell. The work is supported by a bronze-lined tool-holder *G*, and the machine is operated at the same speed and feed as for the fourth operation. The bevel on the inside of the nose is machined by a double-ended cutter of the proper form, which is supported at the center by a toolpost bolted to the base of the fixture. The step is formed by two forming tools carried by toolposts bolted to the base of the fixture.

Sixth Operation:—Finish-ream with reamer *H*. This operation must be performed with great care, as the specifications require that when an electric light is dropped into the hole, the surface will show a uniform polish in all places. This operation is performed with the spindle rotating at 37 R. P. M. with a down feed of 0.093 inch per revolution.

By holding the shell in a fixture on the drill spindle, advantage is taken of the inverted principle which allows the

chips to clear themselves more freely than would otherwise be the case. All the drilling and reaming tools used are of the oil-tube type and are supplied with forced lubrication. The chuck in which the work is held is arranged with three serrated eccentric jaws mounted on a rotating ring. To

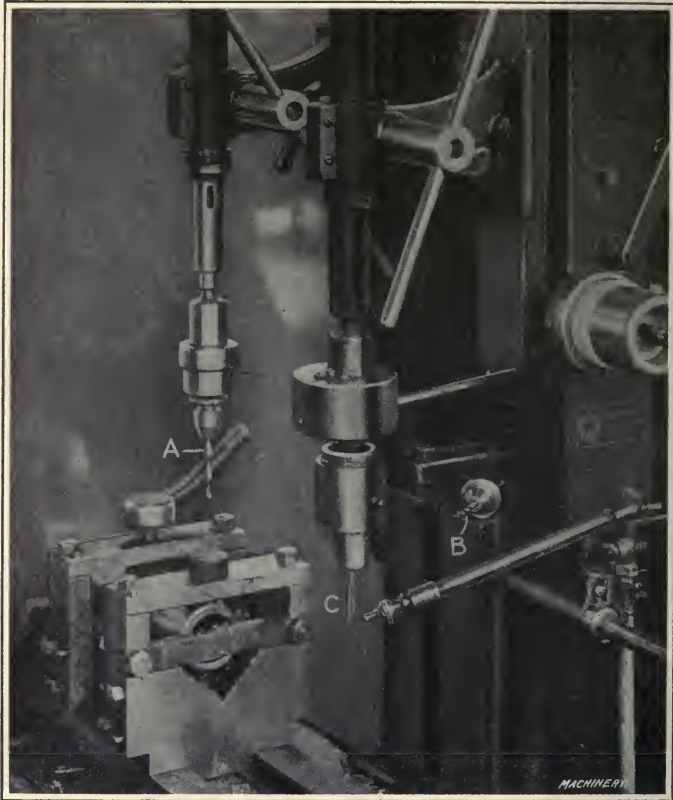

Fig. 43. Drilling and tapping Hole for Fuse Fixing Screw

clamp the work in the chuck, the ring that carries the jaws is turned back against spring tension to allow the work to be pushed up into place. The ring is then released and snaps back to give the jaws a preliminary grip on the shell. When the machining operation is commenced, the resistance of the work to the cutting action of the tools causes a fur-

ther rotation of the ring on which the chuck jaws are carried, with the result that the jaws rock in on their eccentric pivots to secure a firmer grip on the work. After the machining operations have been completed, the work is removed from the chuck by a wrench which is slipped over the end of one of the jaws, and pressure is applied to rotate the chuck ring in the opposite direction from that necessary to tighten the jaws.

Drilling and Tapping for Fixing Screw. — The operation of drilling and tapping the hole in the nose for the fuse fixing screw is accomplished in a two-spindle drilling ma-

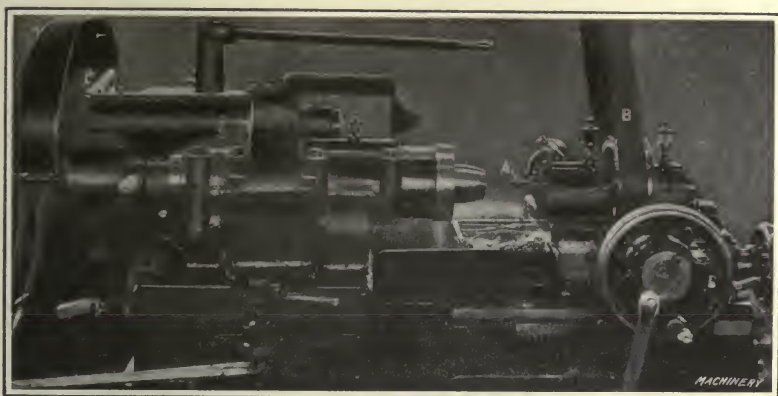

Fig. 44. Milling Threads In Nose In a Special Lees-Bradner Thread Milling Machine

chine as shown in Fig. 43. The first spindle is used for counterboring and drilling. After the hole has been started with drill *A*, it is removed and the smaller drill *B* inserted. The fixture carrying the work is now moved over to the second spindle of the machine and the hole threaded with tap *C*, which is held in an Errington chuck. For this operation, of course, it is necessary to remove the drill guide bushing.

Milling Threads in Nose. — In the special Lees-Bradner thread milling machine shown in Fig. 44, the shell is held in an air chuck with the open end out. The threading is done with a multiple type cutter *A*, of a length sufficient

to completely cover the length of the part to be threaded and which is rotated by a separate belt *B*. The cutter-slide is fed toward the head of the machine, and the work rotated at the same time so as to cut a thread of the correct pitch. This is controlled through a change-gear system located at the left-hand end of the machine.

Turning, Under-cutting, and Waving Band Groove.— Before the machining of the band groove, a center hole is drilled in the base end of the shell. After this operation, the shells go to the preliminary inspection department

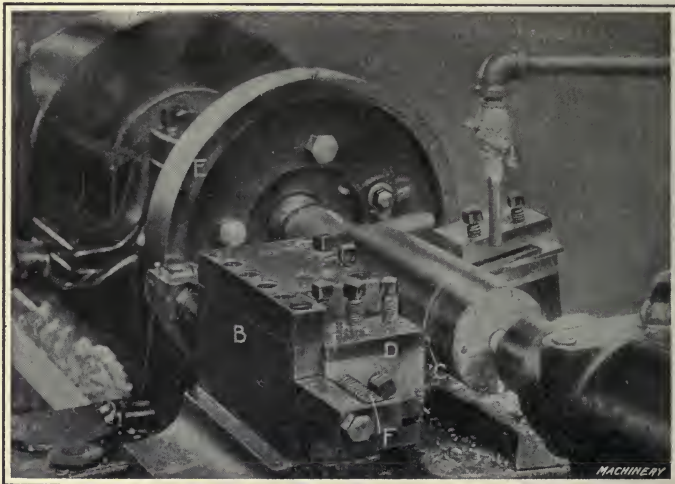

Fig. 45. Turning, under-cutting and waving, Rifling Band Groove

where the thread in the nose is tested with a thread plug gage. A driving center is then screwed into the nose of the shells, and they are returned to the machining department. The band groove is machined as shown in Fig. 45. The roughing out of the band groove is done by means of a formed tool held on the rear cross-slide, which leaves sufficient stock to form the waves. The next step is to under-cut the sides of the band groove by two tools held in the holder *B*; when one tool is in action, the other clears the end of the shell. The machining of the waves is performed by a tool *C* held in the holder *D*. This holder forms part of a slide

which carries a roller that engages with cam *E*. Spring *F* keeps the roll in contact with the cam, so that, when the latter rotates, an oscillating movement is imparted to holder *D*.

Preliminary Inspection. — After the band seats have been machined, the driving centers are removed from the nose of the shells and the latter are subjected to a preliminary inspection. This consists in weighing in order to determine the amount of stock that must be removed from the base to bring the shells to standard weight. The normal weight of the finished shell is 14 pounds, 13.15 ounces, and a tolerance

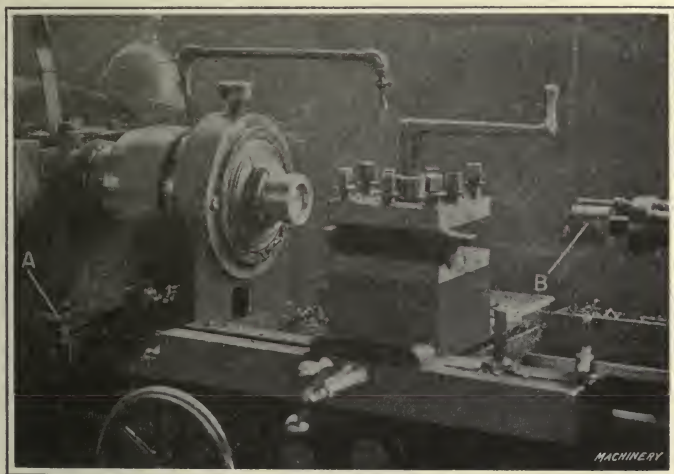

Fig. 46. Facing-off Base End and machining Gas Plug Seat

of 1 ounce is allowed. Experiments have established the fact that each ounce of weight on the shell is equivalent to 0.026 inch in length at the base, so that, by removing the metal on this basis, the weight of the shell may be reduced to normal. The inspector who weighs the shells has a chart before him on which the various weights of shells are type-written, together with the corresponding amount of metal, in thousandths of an inch, that must be removed from the base in order to bring the shell to normal weight. At this stage, the shells also have the heat number of the steel bar stamped on the base; as the metal is to be removed from

the base, the inspector transfers this heat number to the side of the shell. After he has weighed the shell and determined the amount of metal that must be removed, he marks the number of thousandths inch to be removed on the side of the shell with blue chalk; the shells are then sent on to the lathe department where the correction for weight is made while the hole is being bored to receive the gas plug.



Fig. 47. Fixture used for driving in Gas Plugs

Facing Base End of Shell.—The engine lathe used for facing the base end is equipped with a special micrometer attachment which enables quick settings to be made. This attachment, as shown in Fig. 46, consists of a bracket bolted to the lathe bed, on which the spindle of a micrometer *A* is supported. The connection between the micrometer and the supporting bracket is cushioned by a spring, so that, when the lathe carriage is brought up against the mi-

rometer spindle, the spring will take up the strain and prevent the instrument from being damaged.

In operation, the shell is gripped in a Hannifin air chuck and the facing tool brought into contact with the base of the shell. The micrometer spindle is then screwed up against the end of the lathe carriage and a reading taken, after which the spindle is backed away the necessary number of thousandths inch that the inspector has found must be removed from the shell to bring it to normal weight. The carriage is moved out until the tool clears the work, then moved to the left until it makes contact with the micrometer spindle. After this setting, the cross-slide is fed in until the tool passes beyond the circumference of the hole subsequently to be bored. The cross-slide is then backed away from the work and the boring tool *B* held in the tailstock spindle is fed in to bore the hole for the plug. The turret toolpost is then revolved to bring the reaming tool into position to take a finish cut on the side and bottom of the hole. The tool used for this purpose has a double cutting edge with the edges located at right angles to each other. After the finish cut has been taken, the turret toolpost is again rotated to bring the under-cutting tool into the working position, and the under-cut is made.

Gas Plugs. — The shells now go to another Lees-Bradner thread milling machine of the type shown in Fig. 44, where the threads for the gas plugs are milled. These plugs are drop-forgings provided with a triangular head to fit the wrench used in screwing them into the shells. Before being screwed into place, the disks are painted with red lead on the bottom and threads and screwed loosely into the shells. The work then goes to an upright drilling machine, Fig. 47, equipped with a special fixture for use in driving the gas plugs down firmly into the shells. The machine spindle carries a heavy flywheel *A* to give the necessary momentum. The fixture *B* in which the work is held is pivoted on the table of the drilling machine so that it may be swung out of the way of the flywheel for setting up the work and removing the shell after the plug has been driven home, a stop being provided for locating the work under the spindle.

The end of the spindle is fitted with a wrench which engages the triangular nut on the disk when the spindle is fed down. When engagement is made in this way, the momentum of the flywheel drives the disk home with sufficient force to screw it firmly into place, after which the continued motion of the spindle results in twisting the corners off the nut.

It is now necessary to remove the projection from the base of the gas plug, and face off the base of the plug. For this purpose the shells are taken to an engine lathe equipped with a Hannifin air chuck and a turret toolpost. The projection is removed by a roughing tool, after which the turret head is revolved to bring a finishing tool into position to take a light cut across the entire base of the shell. The turret head is again rotated to bring a third tool carrying a hardened tool-steel roller into position. This roller is used to spin over the slight seam between the plug and cavity in the shell. The result is that any slight burr which was raised at the joint during the turning operation is rolled down, making the joint so smooth that it can hardly be seen.

Pressing and Forming the Copper Band. — The shells now go to a West Tire Setter Co. banding press, where the copper band is pressed into the groove. After this has been done, the shells are passed on to an engine lathe equipped with a Hannifin air chuck and formed tools for forming the bands. Two forming tools are used for this purpose, the roughing tool being a radial tool carried at the front of the fixture bolted to the cross-slide, whereas, the finishing tool is of the tangential type and is located at the back of the fixture. The shells are then taken to a Dwight Slate stamping machine, where they are marked. They are then washed in hot soda water to remove the grease, after which they are washed in alcohol to remove all traces of soda. As the shells come from the alcohol bath, they are taken out and placed on an inclined table, on which they roll down until they come into contact with an accumulation of shells at the base. These shells are in a convenient position for the man who performs the painting operation on the inside. The device used for this purpose consists of two rol-

lers, which are normally located beneath the surface of the bench. When the operator is ready to paint a shell, he takes it from the bench and places it in position over the hole through which the rollers are raised by depressing a foot-treadle. The result is that the shell is held between two rollers which impart a rotary motion to it. The painter then takes a round brush of suitable size, dips it into the shellac pot and pushes it into the shell. An experienced painter can varnish shells very rapidly by this method.

After the varnish in the shells has dried, they are inspected; the production is 1000 per day of twenty-three hours. Eight shells from each day's production are sent to the proving grounds for test, and as soon as a favorable report has been obtained, the shells are shipped to the loading factory.

CHAPTER V

MACHINING RUSSIAN AND SERBIAN SHELLS

FOLLOWING the forging of the Russian 3-inch high-explosive shell, Fig. 48, the first machining operation is cutting off the open end. This is done in a Curtis & Curtis shell cutting-off machine, as shown in Fig. 49. The forging is located by means of the gage shown at the front of the machine, and the cutter head, carrying four radial cutters, is rotated about the stationary shell. The cutters are auto-

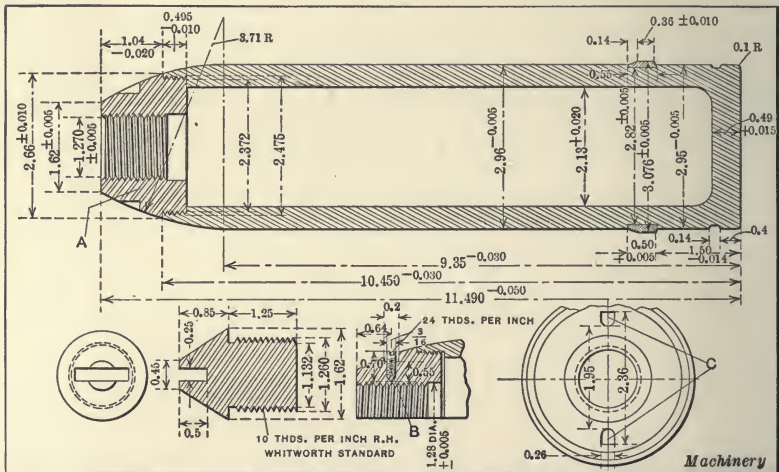

Fig. 48. Russian 3-Inch High-explosive Shell and Plug

matically fed into the work and at the end of the cut are returned to the starting point. The cutting is done at a work speed of 65 surface feet per minute, and a lubricant called "Cut-cool" is used for cooling and lubricating the work. The wall of the shell is about $\frac{1}{2}$ inch thick, and the cutting off is done at the rate of fifty shells per hour. On an average, 100 shells are cut off before the cutters

require grinding. The base end is now centered in a Rockford drilling machine provided with a special arbor mounted on the table over which the shell is slipped. After being centrally located, the shell is drilled and countersunk with a combination center reamer.

Heat-treating Russian High-explosive Shells.—It is the practice of one plant to heat-treat the Russian high-explo-

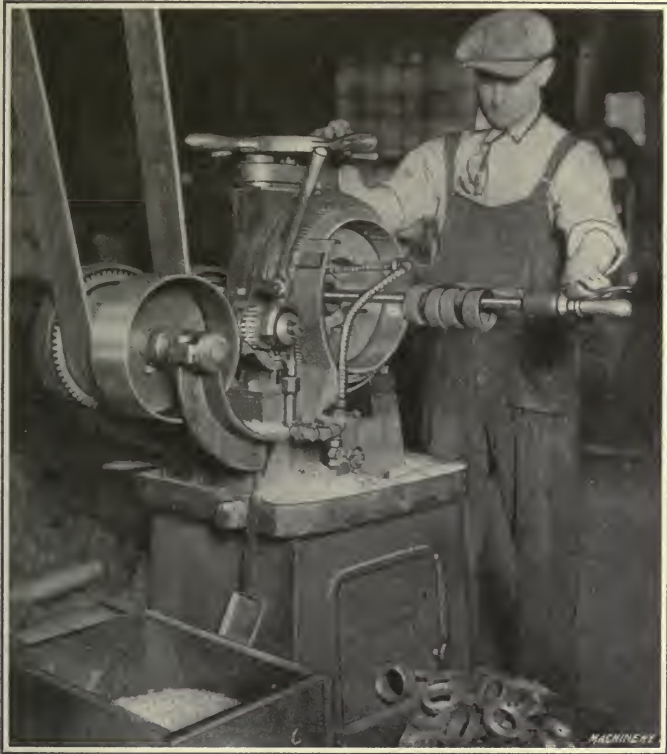

Fig. 49. Cutting off Open End of Shell Forging

sive shell before any of the important machining operations are performed; in fact, it is heat-treated after the centering operation just described. Fig. 50 shows the furnace used for heating the shell previous to quenching; this is designed and built by the Laconia Car Co., and is shown in detail in Fig. 22. The shells are loaded into the furnace seven at a

time by a special fork mounted on wheels, as shown in Fig. 50. The furnace holds thirty-five shells, and it requires thirty-five minutes to heat one lot of shells to the desired temperature—1470 degrees F. (about 800 degrees C.). In removing the shells from the furnace, the fork is rolled under a layer of seven shells, which are pulled out, the shells are gripped by a pair of tongs, and quickly immersed in a bath of running water. They are placed on racks at



Fig. 50. Heating Russian High-explosive Shell Forgings for Hardening

the bottom of the bath and allowed to get thoroughly cool before removing.

The tempering is done in lead baths, also designed and built by the Laconia Car Co., which are 34 inches wide, 34 inches high, and 4 feet 9 inches long. The lead pot proper is of cast iron with one-inch walls, and measures $12\frac{1}{2}$ by 14 by $24\frac{3}{4}$ inches. It is surrounded by a $1\frac{1}{4}$ -inch firebrick lining. One burner is used to heat the lead bath to 1100

degrees F. (about 600 degrees C.); this burner consumes $4\frac{1}{2}$ gallons of fuel oil per hour. The shells are completely submerged in the bath for seven minutes, then taken out and allowed to cool slowly in the sand. To keep the shells below the surface of the lead bath, they are suspended on pins held on a crank, which is turned to force the shells down or bring them up as required. Five men, with the aid of three muffle furnaces and two lead pots, can heat-treat 100 shells per hour.

Rough-turning External Diameter. — Following heat-treating, the shells are rough-turned in a 16-inch lathe, as

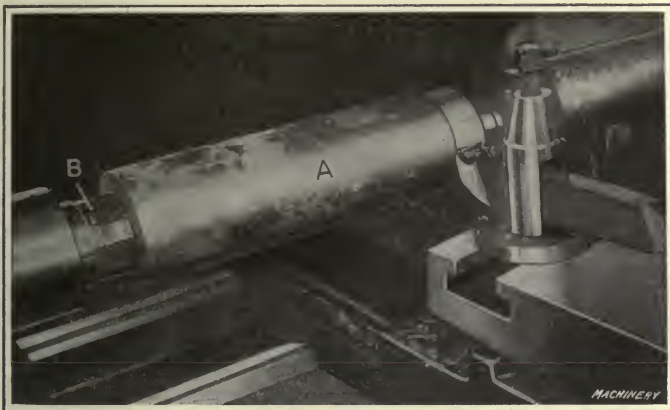

Fig. 51. Rough-turning External Diameter

shown in Fig. 51. The shell *A* is supported at the closed end on the lathe center, and is supported and driven from the open end on the taper mandrel *B*. This resembles a reamer in shape, but is not provided with cutting edges. A single cutting tool is used and the depth of the cut varies from $\frac{3}{16}$ to $\frac{1}{4}$ inch on the diameter. The work is rotated at a surface speed of from 60 to 70 feet per minute, and the feed is $\frac{1}{16}$ inch per revolution.

Machining Interior of Russian High-explosive Shell. — The boring, counterboring, and reaming operations on the interior of the Russian high-explosive shell are performed on a turret lathe, as shown in Fig. 52. The order of opera-

tions is as follows: First, bore mouth of shell with boring tool *A*; second, rough-drill entire length of shell with tool *B*; third, finish-drill with tool *C*; fourth, finish bottom of shell with tool *D*; fifth, finish-ream entire length of shell with tool *E*; and sixth, counterbore with tool *F*.

Following the operations on the inside, the shell is held in a three-jaw chuck on a Davis lathe, and the solid end is rough-faced. After this, the shell is again chucked and the mouth is recessed preparatory to threading. Following this, the shell is held in a four-jaw chuck, as shown in Fig.

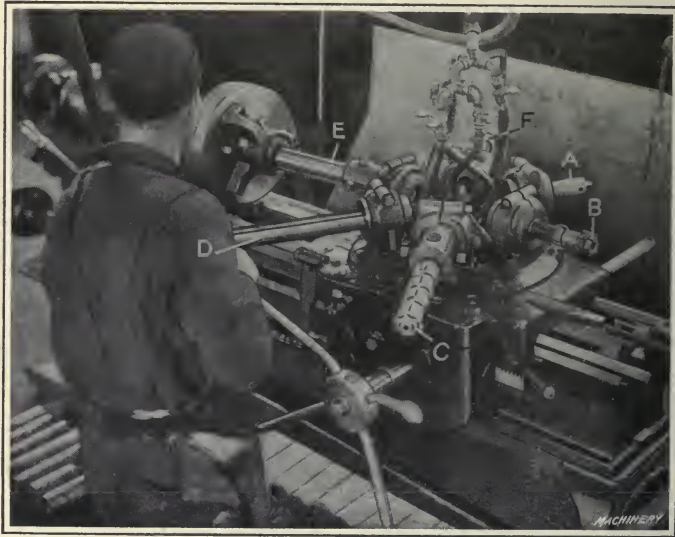

Fig. 52. Boring, counterboring and reaming Cavity of Russian High-explosive Shell

53, the outer end being supported by a steadyrest. The operations performed at this setting consist in roughing out the thread with tool *A*, taking a light cut across the end with tool *B*, and finishing the thread with tap *C*.

Final Turning, Facing, and Banding Operations. — The base end of the shell is now finish-faced, the corners rounded slightly, and the band groove cut. The next step is to machine the under-cut in the band groove, which is performed by means of a special fixture. After this, the adapter or

nose is fitted into the end of the shell, and the end of the shell is machined to shape. This operation is performed by



Fig. 53. Facing and threading Nose of High-explosive Shell

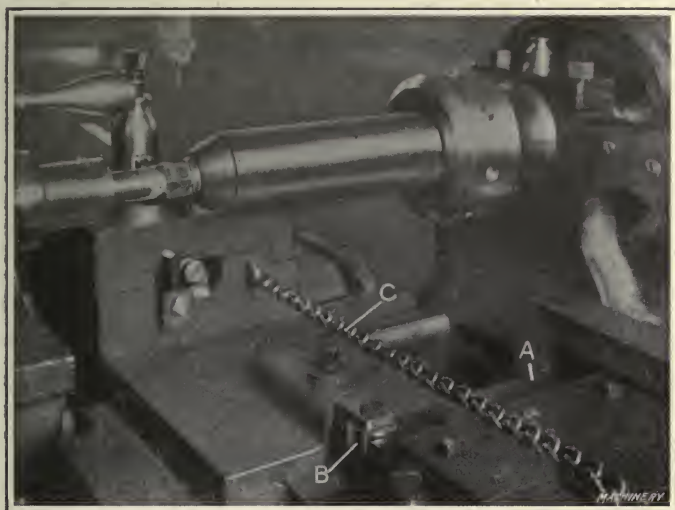

Fig. 54. Turning Radius on Nose of Shell

inserting a nose plug that is used as a center, as shown in Fig. 54. The radius turning is done by means of a former-

plate *A*, against which the roll *B* held on the carriage is pulled by a heavy weight attached to chain *C*. Grinding of the body of the shell is now performed on a plain grinding machine, in which the three-operation method is employed. This is followed by pressing on the band, which is done in a West Tire Setter Co. shell banding press. The rifling band is now formed to the required shape in a Jenckes machine, as shown in Fig. 55. Here, the shell is held in a three-jaw chuck and the band is formed to shape by a single forming cutter. Proper location of the shell in the chuck is obtained by a gage located within the chuck.

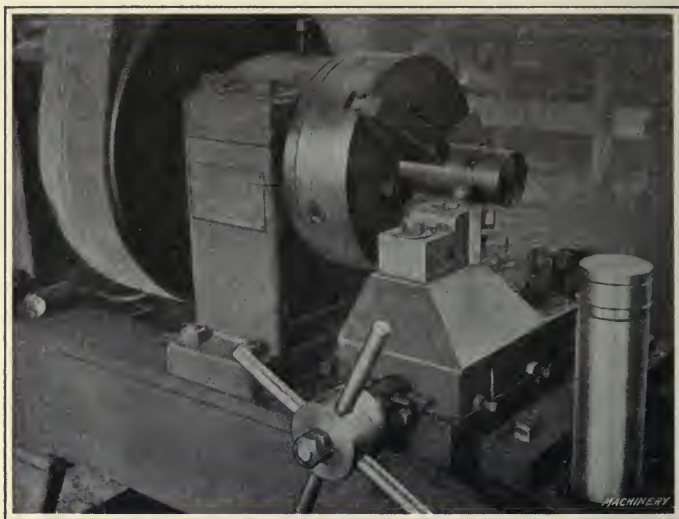

Fig. 55. Turning Copper Band on Jenckes Machine

Machining the Adapter or Nose.—The nose or adapter *A*, Fig. 48, for the Russian high-explosive shell is turned from bar stock in a $3\frac{1}{4}$ -inch Gridley automatic turret lathe. The first operation, after feeding the stock to the stop, is drilling and rough-turning the outside and thread diameter. These operations are performed from the turret and the work speed is 120 R. P. M., the feed of the tools being 0.009 inch per revolution of the work. The tools held on the second turret face counterbore and finish-turn the thread

TABLE III. ORDER OF MACHINING OPERATIONS ON SERBIAN 75-MILLIMETER HIGH-EXPLOSIVE SHELLS

Number of Operation	Character of Operation	Machine	Tools	Feed in Inches	Speed, R.P.M.	Production Per Hour
1	Cutting off Open and Closed Ends	Espen-Lucas Cold Saw	16
2	Centering	Engine Lathe	Combination Drilling and Centering	30
3	Facing and Beveling	21-inch Engine Lathe	84	5.5 to 6
4	Rough-turning	17-inch Engine Lathe	0.024	57	5.5 to 6
5	Semi-finish Turning	17-inch Engine Lathe	0.040	71	9 to 10
6	Rough-bore, Finish-bore, Tap	Double Spindle Flat Turret	3.5
7	Rough, Finish, Knurl Band Groove	21-inch Engine Lathe	Boring Tools, Tap Cutting Tools, Knurl Under-cutting Tool	9 to 10
8	Finish-turning	17-inch Engine Lathe	Turning Tool	10 to 11
9	Final Finish-turning	17-inch Engine Lathe	Turning Tools	12
10	Remove Base End Projection	Band Saw	120
11	Face Base End	17-inch Engine Lathe	11 to 12
12	Drill, Turn, Face, Chamfer, Bore, Neck, Thread, Form, Cut off—Ogive	4¼ Gridley Single Spindle Automatic	0.008-0.012	80-140	8-6
13	Cut Internal Thread—Ogive	Automatic Threading Lathe	72
14	Cut External Thread—Ogive	Pratt & Whitney Turret Lathe	Circular Tool Expanding Thread-Stud Mandrel	24-60
						Machinery

diameter, and at the same time the forming tool is formed with the work rotating at 36 R. P. M. The brought in to form the nose to shape. At the third production on this part is from six to seven pieces station, the thread is rough-cut with a die and fin- per hour. The second operation on the adapter is boring ished at the fourth position. The threading is per-

out the center hole and cutting the internal thread; this is done on a 14-inch lathe. The first step is to take a light finishing cut from the hole, after which it is threaded. The production is about four pieces per hour. The drilling, counterboring, and tapping of the hole for the set-screw *B*, Fig. 48, comes next, and this is performed on a three-spindle sensitive drilling machine; the production is twenty pieces per hour. The two wrench holes *C* are then milled in a hand milling machine, one at a time; the production is sixty per hour.

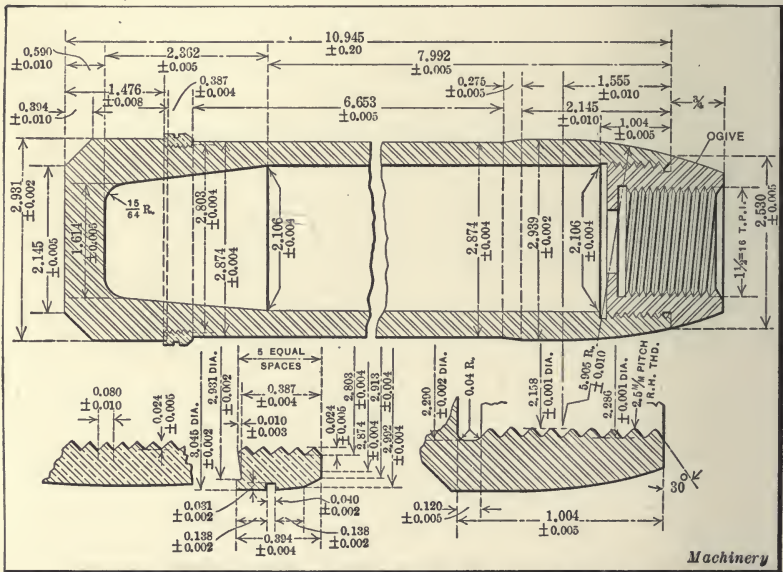

Fig. 56. Serbian 75-millimeter High-explosive Shell

Machining Serbian 75-millimeter Shells.—After the forging has been completed, the first machining operation on the Serbian 75-millimeter high-explosive shell shown in Fig. 56 is cutting off the open and closed ends; the full series of operations is given in Table III. The cutting of the ends is done on an Espen-Lucas cold saw, as shown in Fig. 57, at the rate of 160 per day. In this operation, in addition to cutting off the excess stock on the open end, about 3/16 inch of stock is removed from the closed end of

the forging. The illustration shows that three shells are loaded in one side of the machine by the swinging arm carrying the three gages while the saw is operating on the three shells on the other side.

Following this operation comes the centering, which is done on an engine lathe, as shown in Fig. 58. The mandrel on which the work is held carries two sets of three fingers that are expanded by a tapered draw-in bar operated by a handwheel at the rear of the spindle. A combination drilling and centering tool is used, and the production is 300 shells per day.

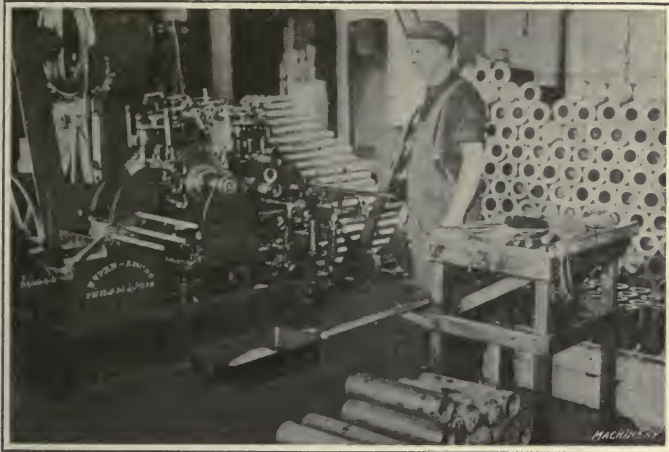

Fig. 57. Cutting off Excess Stock from Open and Closed Ends of Forging

Turning and Boring.—The shells now go to the turning department where the first operation is facing and beveling the closed end. Reference to Fig. 56 will show that the Serbian shell has a pronounced bevel at the base end, and this is roughed out at this time and the base faced, leaving a teat about $11/16$ inch in diameter. The facing and beveling is done on a 21-inch engine lathe, using two tools, one of which cuts the bevel and the other faces the end. The cutting speed is 65 feet per minute; the production is from fifty-five to sixty shells per day.

The next operation is rough-turning, as shown in Fig. 59.

This is accomplished on a 17-inch engine lathe, at a work speed of 44 surface feet per minute. The amount of metal removed averages $\frac{3}{8}$ inch on the diameter, and the feed is 0.024 inch per revolution of the work. This rough-turning operation leaves the shell about 0.050 inch larger than the finished size. The production is from fifty-five to sixty shells per day. Following this, a semi-finish cut is taken from the external diameter on a 17-inch engine lathe. For this operation the work speed is 55 surface feet per minute. The amount of metal removed is 0.025 inch on the diameter,

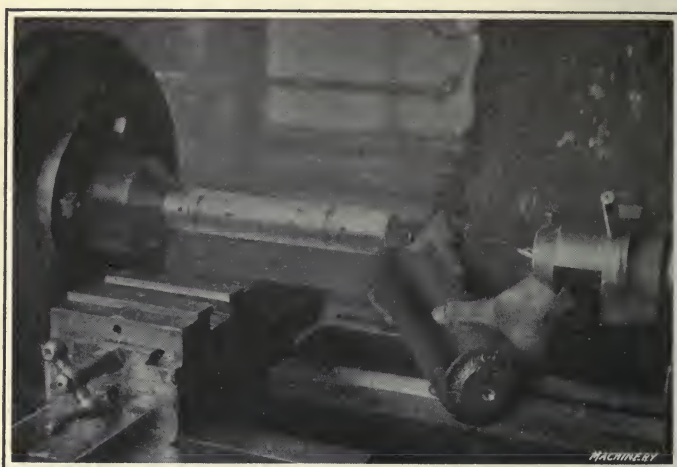

Fig. 58. Centering Closed End of Forging

and the feed is 0.040 inch per revolution. The production is from ninety to one hundred shells per day.

The machining operations on the cavity of the shell are performed on double-spindle flat turret lathes. In the first position, the operation performed is rough-boring with a single-point tool, removing $\frac{1}{4}$ inch of stock from the diameter; second, roughing out taper with a flat boring tool and recessing mouth with another tool held in the same bar; third, finish-boring full length of hole with a combination straight and taper boring tool, also boring diameter to be threaded; (The boring tool-holder used carries two blades, one set at right angles to the other; the first tool bores the taper sec-

tion and part of the straight section, whereas, the second tool finishes the straight section only.); fourth, tapping mouth end of shell. The production is thirty-four shells per day.

A center plug is now screwed into the open end of the shell and it is taken to the 21-inch engine lathe shown in Fig. 60. The lathe is provided with a turret toolpost, and carries three cutting tools and a knurl. The first operation is to cut the groove with a broad-nose tool; second, cut two concentric rings (one for crimping in cartridge case) with

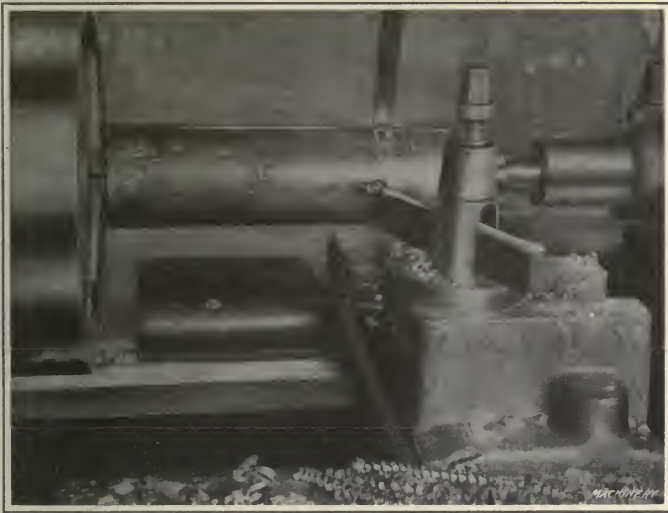

Fig. 59. Rough-turning External Diameter of Shell

a forming tool; third, under-cut base side of band groove 0.010 inch under-cut; fourth, knurl band groove. The production is from ninety to one hundred shells per day. The shell is now taken to a 17-inch engine lathe, where a light cut is taken from the external diameter, leaving it 0.015 inch over size. The turning commences at the rifling band groove and terminates at a point about two inches from the nose. The production is from 100 to 110 shells per day.

Finishing the Machining.—Following this is the final finishing, which is accomplished in a 17-inch engine lathe.

Two tools are used for this operation; one is set to the finished size of the shell at the base end back of the band groove, and the other is set for the reduced size. The purpose of this reduction is to allow clearance for the shell in passing through the gun. The production is 120 shells per day. The projection on the base end of the shell is now removed on a band saw. This is done at the rate of two shells per minute. After sawing off the center projection, the base end is squared up on a 17-inch engine lathe. The turret toolpost carries two tools; one of these faces the end and the other trues up the bevel. The production is from 110 to 120 per day. Before any other operations are performed on the shell, the ogive is assembled.

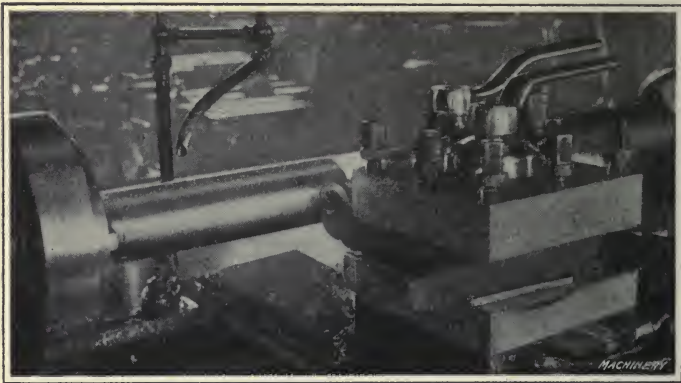

Fig. 60. Turning and Knurling Band Groove

Machining Ogive for Serbian Shell.—The ogive that fits in the nose of the Serbian 75-millimeter high-explosive shell is turned out from bar stock containing about 50 points carbon. The first operation is performed on a 4¼-inch Gridley single-spindle automatic. The bar is fed to the stop located on a “corner” of the turret slide; the operations are: First, drill the small hole, and, at the same time, take a light cut from external diameter and face end of work; second, bore hole from turret, also chamfer inside with a hook tool; third, neck at base of thread with a regular Gridley internal necking tool, and, at the same time, form

outside diameter to full width with a forming tool carried on the cross-slide; fourth, cut off. For centering, boring, and facing, the stock revolves at 140 R. P. M. and the feed is 0.010 inch per revolution. For forming, the speed is slowed down to 80 R. P. M. and the feed to 0.008 inch per revolution. The cutting off is done at a spindle speed of 140 R. P. M. with a tool feed of 0.012 inch. Production is eight per hour.

The cutting of the internal thread is done on an "Automatic" threading lathe,

using a circular tool on the bar. The spindle of the machine rotates at 72 R. P. M. and it takes from fifteen to twenty passes of the tool to complete the thread. The production averages six pieces per hour. The thread on the external diameter is cut on a turret lathe, where the work is held on an expanding threaded-stud mandrel. The operations are: First, face the



Fig. 61. Assembling Ogive In Shell Nose

of the ogive that comes in contact with the front end of the shell; second, thread external diameter; third, chamfer thread and burr hole. The facing and burring operations are accomplished at a spindle speed of 60 R. P. M., whereas, for threading, the speed is cut down to 24 R. P. M.

Setting in the Ogive. — After the ogive has been completely machined, it is assembled in the nose of the shell, which is done on a drilling machine, as shown in Fig. 61. The shell is gripped in a hinged fixture fastened to the table of the drilling machine and a special tool similar in shape

to an inverted cone, the inside surface of which is serrated, is used to assemble the ogive in the shell. The ogive is started into the shell by hand and then the tool is brought down in contact with it, driving it down to the seat.

The shell is now taken to a 17-inch engine lathe where the radius is turned, as shown in Fig. 62. Here it is gripped in a collet chuck, being located centrally in this chuck by means of a special gage located on the tailstock spindle. After clamping, the turning tool *A* is brought in contact with the work and is guided in its operation by



Fig. 62. Turning Ogive in Open End of Shell

means of a former-plate *B* fastened to a fixture held to the bed of the lathe. The movement of the cross-slide is controlled by a roller *C* that makes contact with this former-plate, the latter being kept in contact with the plate by means of two ropes to which weights are attached and which run over pulleys, as illustrated. The production is seventy per day.

Following the turning of the nose, the copper band is now pressed into the groove in a West Tire Setter Co.'s banding press. The bands are annealed before being

pressed on the shell and two squeezes are necessary to compress the band into the groove. The copper band is now turned to shape in a 14-inch engine lathe carrying a special forming tool that covers the entire width of the band. This operation is handled at the rate of ninety shells per day. The shells are now inspected before they go into the hands of the government inspector. The inspection operation consists in checking up the diameter of the band and the ogive to see that they are held tightly in place. The shell is stamped on a Noble & Westbrook stamping machine. The



Fig. 63. Spraying Interior and Exterior of Shell with Copal Varnish

stamp is in the form of a roll that is passed over the end of the shell, pressure being applied by means of a foot-treadle. Prior to the varnishing which follows, the shells are washed, after which they are dried.

Varnishing Interior and Exterior of Serbian Shells.— The shells now go to the lacquering and spraying department where they are sprayed inside and outside and painted on the outside previous to shipment. For the spraying of the outside of the shell, a special De Vilbiss spraying torch is used as shown to the right in Fig. 63, whereas the internal diameter is sprayed on a special machine shown in the

background of the same illustration. Copal varnish is used for spraying; this prevents the high-explosive from coming into contact with the shell.

Internal Spraying Machine. — The operation of the internal spraying device is more clearly shown in Fig. 64. For this operation the shell *A* is placed on two pairs of rollers *B*, which are rotated by a one-half horsepower electric motor. The shells revolve at the rate of 300 R. P. M. and they are placed on the rollers and removed from them after the spraying is done and while the rollers are still in motion.

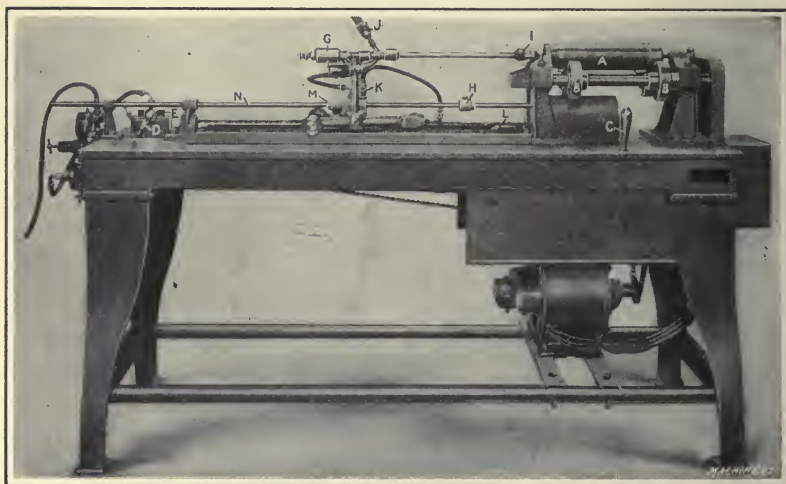

Fig. 64. De Vilbiss Spraying Machine for coating Interior of High-explosive Shells

The rollers are driven by means of a chain from the motor through a countershaft. The operation of the spraying member of the machine is as follows: With the rollers in motion and the machine in the position shown in Fig. 64, lever *C* is thrown to the left to start the machine; this releases a catch that holds lever *D* in a neutral position. The releasing of the catch allows a coil spring to pull lever *D* into the position shown, this lever being connected to the valve *E*. When this valve is operated, the air passes through it to a cylinder provided with a piston, the forward motion of which operates a cone clutch that starts carriage

F moving to the right. When the carriage *F* strikes stop *H*, the rod upon which it is held moves forward with the carriage until the coil spring is pulled over the center line of lever *D*, at which point valve *E* is operated to return the carriage. At the same time that carriage *F* starts to move to the left, the air valve starts the spraying device *G*.

There are two nozzles in the end of torch *I* that throw a stream of varnish in two directions. The end of the shell as well as the sides are covered as the carriage moves to the left. The varnish or other material used flows down through the flexible metal hose *J* from a five-gallon container suspended above the machine. When the spraying torch reaches the point where the shoulder of the ogive is coated, a cam mounted on the bed of the machine trips the air valve *K*, which stops the spraying. This valve is in circuit with the valve that starts the spray

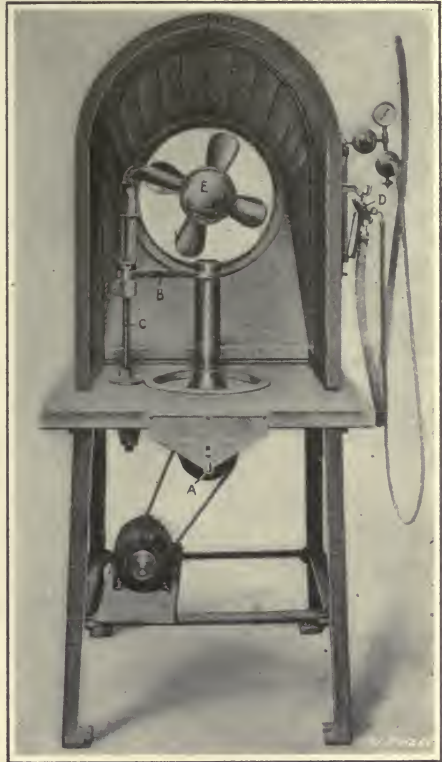

Fig. 65. De Vilbiss Spraying Device used in coating Exterior of High-explosive Shells

so that the air passes through both of them. (Valve *K* is opened on the forward stroke by cam *L*, but the other valve is closed at that time and the spray does not start.) The carriage continues to the left until it strikes stop *M*, which moves the rod *N* back to the point where the lever *D* is

pulled back by the spring. A trip serves as a stop to hold lever *D* in a neutral position until it is again thrown. The throwing of lever *D* into the neutral position releases the air pressure on the piston holding the clutch in engagement, and a spring pushes the clutch out, stopping the motion of the carriage. The production is 400 shells per day.

External Spraying Machine. — The special De Vilbiss machine for spraying the exterior of high-explosive shells is shown in Fig. 65. The spraying of the outside is done after

the inside has been sprayed. In spraying, the shell, as shown in Fig. 65, is placed on a vertical revolving spindle which is driven by a one-sixth horse-power electric motor at a speed of about 250 R. P. M. through a belt and friction disk drive. The amount of spray is adjusted by changing the position of the wheel which engages with the friction disk. Lever *A* serves to

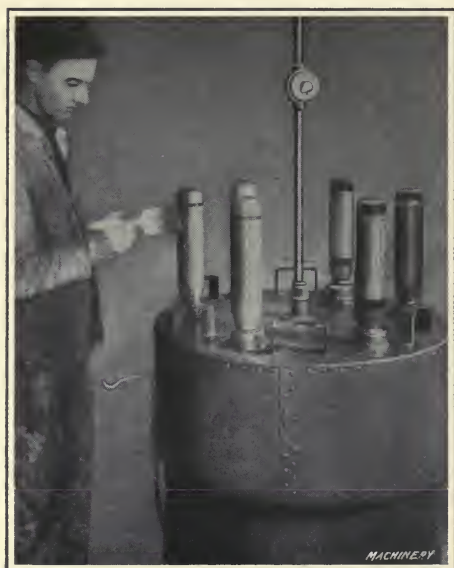

Fig. 66. Painting Exterior of High-explosive Shells

move the wheel in and out of engagement and is used to automatically stop and start the machine between the spraying of the shells. The adjustable guard *B* is mounted on post *C* and swings in against a stop which pulls it into position and covers the copper driving band of the shell, protecting it from the varnish. The shell is sprayed, while revolving, with a De Vilbiss standard type L "Aeron" shown at *D*, the operator holding this device in his hand as shown in Fig. 63. The exhaust fan *E* removes the vapors caused by the spraying operation. This fan is operated by a one-half horsepower motor, entirely enclosed to

protect it from the vapors, and the motor is automatically cooled by the clean air being drawn through it by the action of the fan. The production on this machine is between 400 and 500 shells per day.

Painting and Drying Shells.— Afterspraying, the shells are placed in a Steiner baking oven heated to 300 degrees F. (about 149 degrees C.), where the shells are baked for eight hours. They are then taken to the Canadian Fairbanks-Morse painting machine shown in Fig. 66 where they are given a coat of yellow paint. This painting machine consists of a stand on which there are six spindles, each of which rotates continuously. The shells are placed upon the spindles, and, as they rotate, the painter holds his brush on the shell and applies the yellow paint. The band is not painted. One man can handle 250 shells per day with this machine, although it is generally used with a battery of two painters and one cleaner, when the average production is 750 shells. Once more the shells are placed in drying ovens that are kept at a temperature of 150 degrees F. (about 66 degrees C.), and ten hours in these ovens completes the drying of the shell; it would require twenty hours to dry in the atmosphere. After drying, the shells are wrapped in oil paper and packed ready for shipment.

CHAPTER VI

MACHINING FRENCH 120-MILLIMETER (4.72-INCH) SHELLS

THE following description applies to the manufacture of the French, 120-millimeter, high-explosive shell, which is made from a seamless steel forging of the proportions shown at *A*, Fig. 67. The forging is machined to the shape shown at *B* and is then nosed-in, after which a second series of operations is performed, bringing it to the shape shown at *C*. The first operation is to pickle the forgings to remove the scale; this is done in a solution made up of sulphuric acid 1 part, water 10 parts. The temperature of this solution should not be raised above 150 degrees F. (about 66 degrees C.), as a higher temperature produces fumes that are very annoying. The forgings are pickled in this solution for one hour and then washed in a bath of hot lime-water to remove all traces of the acid.

Sorting and Grinding Base End.—The next operation consists in sorting the forgings for size, with particular reference to the diameter of the cavity. The forgings are received in the plant in three lots: Those exactly 94 millimeters (3.7 inches), those below, and those above this dimension. As a certain thickness of wall must be maintained in this shell, the variation on the inside diameter of the forging is carried to the external diameter, and on forgings in which the cavity is larger than the exact size of 94 millimeters, the external diameter is made slightly larger to allow for this. It is therefore necessary that the forgings be sorted and machined in different lots. After sorting, they are taken to the Gardner double-spindle disk grinder shown in Fig. 68, where the projection on the closed end is surfaced for centering. Here the forging is held in a special cradle fixture fastened to the swinging table and is held

in place by a clamp as shown. The wheel used is a carborundum cylinder wheel, 16 inches in diameter, with a 2-inch rim. The speed of the wheel is 1200 R. P. M., the amount of stock removed from 1/32 to 1/16 inch, and the production about thirty per hour. The complete order of operations is given in Table IV.

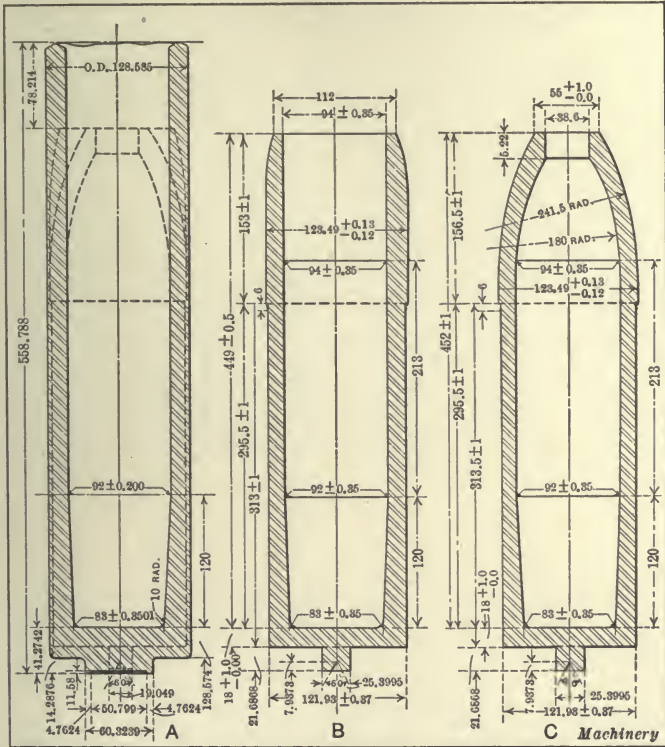

Fig. 67. Principal Dimensions of Forging and Condition of French 120-millimeter High-explosive Shell after First Series of Machining Operations

Cutting Off Open End of Shell and Centering Closed End. — From the disk grinder, the forgings are taken to the lathe shown in Fig. 69, where the open end is cut off, bringing the forging to the desired length. The forgings are held on an expanding mandrel operated by a special air chuck as shown in Fig. 70. Here the forging is shown, by heavy dotted lines, gripped near the open end by an ex-



Fig. 68. Grinding Base End of French 120-millimeter High-explosive Shell Forgings in a Gardner Disk Grinder

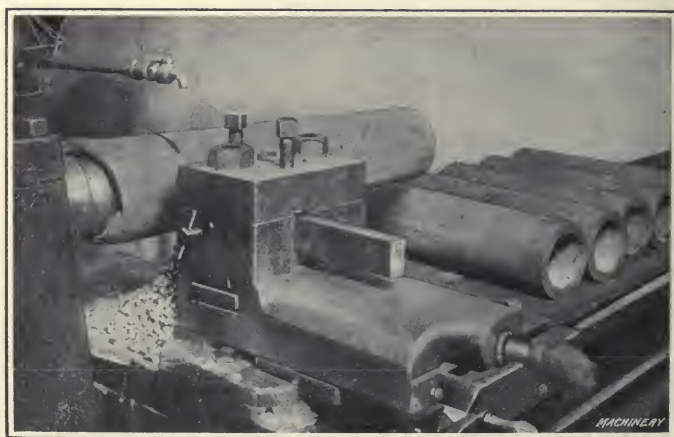

Fig. 69. Cutting off Open End of High-explosive Shell Forging

TABLE IV. ORDER OF MACHINING OPERATIONS ON FRENCH 120-MILLIMETER HIGH-EXPLOSIVE SHELL

Number of Operation	Character of Operation	Machine	Tools	Feed, Inches	Speed, R.P.M.	Production Per Hour
1	Disk Grinding Base End	Gardner Grinder	"American" Wheel	2500	30
2	Cut off Open End	Engine Lathe	"Cyclops" No. 5	Hand	56	15
3	Drill Center	U. S. Elec. Tool	Center Drill	Hand	Work 60 Drill 7250	45
4	Face Closed End	Engine Lathe	"Cyclops" No. 5	56	6
5	Rough-turn	"Lo-swing" Lathe	4
6	Nose-in Open End	Beauty Hammer	30
7	Face End and Bore	Engine Lathe and J. & L. Frankfort Furnace	15
8	Heat-treat	Brinell Test	25
9	Inspect for Hardness	Williams Tool Co.	60
10	Recenter Base End	Flat Turret Lathe	Center Drill	200
11	Bore and Thread Nose	"Lo-swing" Lathe	Murchey Taps	7
12	Finish-turn	Norton Grinder	"Novo Superior"	0.020	40	4
13	Grind	West Tire Setter Co.	Norton Wheel	8
14	Pressing Copper Band	16" Engine Lathe	20
15	Turning Copper Band	Williams Cutting-off Machine	20
16	Cutting off Projection	Gages and Weighing Scales	24
17	10 Testing Operations	Metalwood Co. Press
18	Testing for Strength

Machinery

panding collar A provided with serrations around effected throughout rod C, which is connected to its periphery. The forging is located by adjusting collar A by pin D, rod C, in turn, being drawn screw B and is forced up tight against this stop back to expand collar A by a Hannifin air-chuck before the air cylinder is operated. Clamping is cylinder located at the rear end of the machine

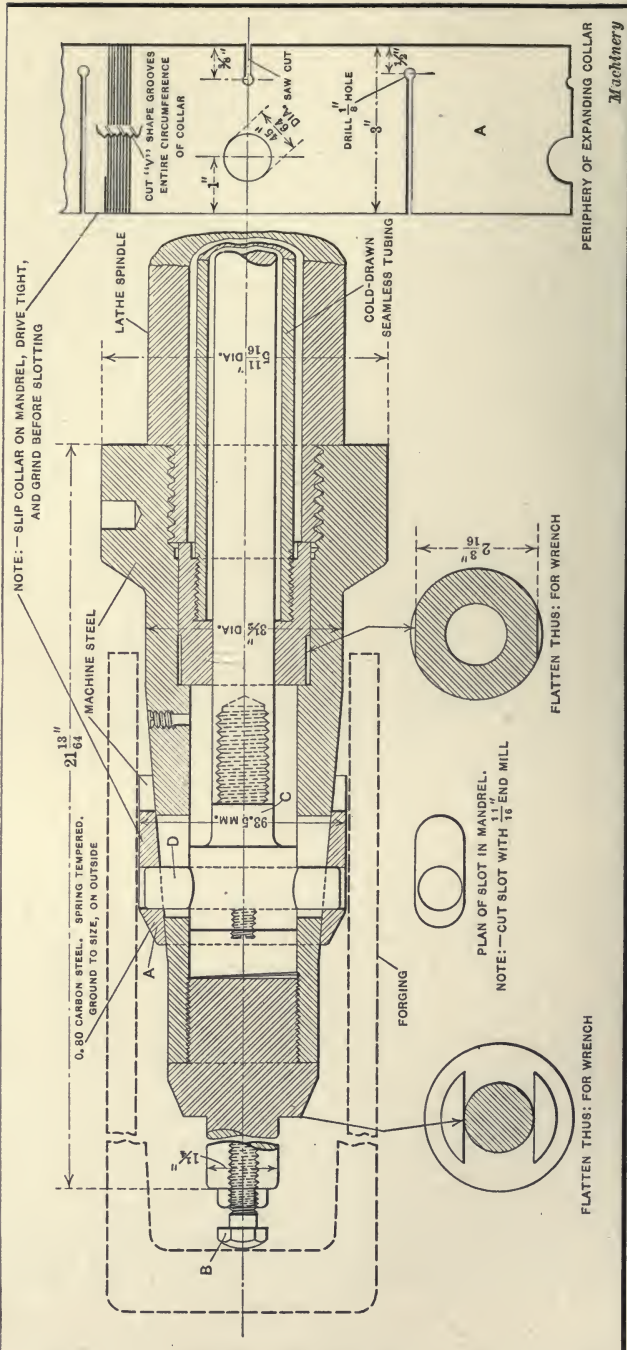

Fig. 70. Expanding Mandrel used in holding Shell Forgings when cutting off Open End

spindle. For this operation, the work is rotated at 70 feet surface speed and the production is fifteen per hour. After cutting off, the shell is gaged to length by the gage shown in Fig. 71. This gage has graduations on the bar, giving the limits.

The centering of the closed end is accomplished in an engine lathe as shown in Fig. 72. The lathe is provided with a Hannifin air chuck, operating an expanding mandrel of



Fig. 71. Gage used in testing Length of Trimmed Forgings

the type shown in Fig. 73, on which the forging is held. This mandrel differs somewhat in construction from that shown in Fig. 70 in that, in addition to clamping the forging, it centers it accurately from the internal diameter. In construction, this mandrel comprises a main sleeve *A*, which is screwed onto the spindle of the machine, and inside of which passes a rod *B* and sleeve *C*. Rod *B* and sleeve *C*

are provided with tapered bearings that operate clamping blocks *D* and *E* against the tension of flat springs *F* and *G*. These blocks are located equidistantly around the circumference of the mandrel and engage the interior of the forging near the base end and about $1\frac{1}{2}$ inch from



Fig. 72. Centering Closed End of Forging

the open end, respectively. Sleeve *C* of the chuck is forced forward when rod *B* is drawn back and *vice versa*.

Centering is done with a United States electric drill held in a cradle *A*, Fig. 72, which is fastened to the cross-slide of the lathe and consequently moves with it. The centering tool is guided by a plate *B* fastened to the cross-slide which holds the tool in line with the axis of the machine

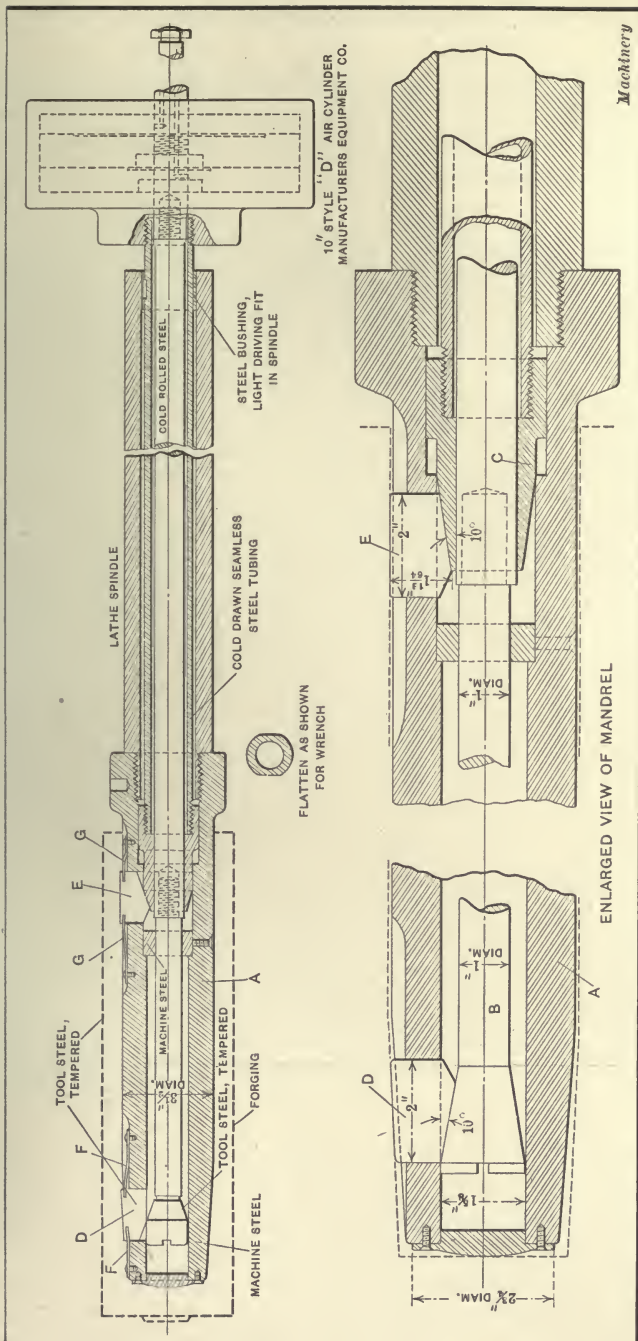

Fig. 73. Air-operated Mandrel used in holding Shell Forgings when Centering and Turning

and drill spindles. The center hole is drilled and counter-sunk $\frac{5}{8}$ inch deep. The work is rotated at 25 feet surface speed and the drill at 175 surface feet; the production is forty-five shells per hour.

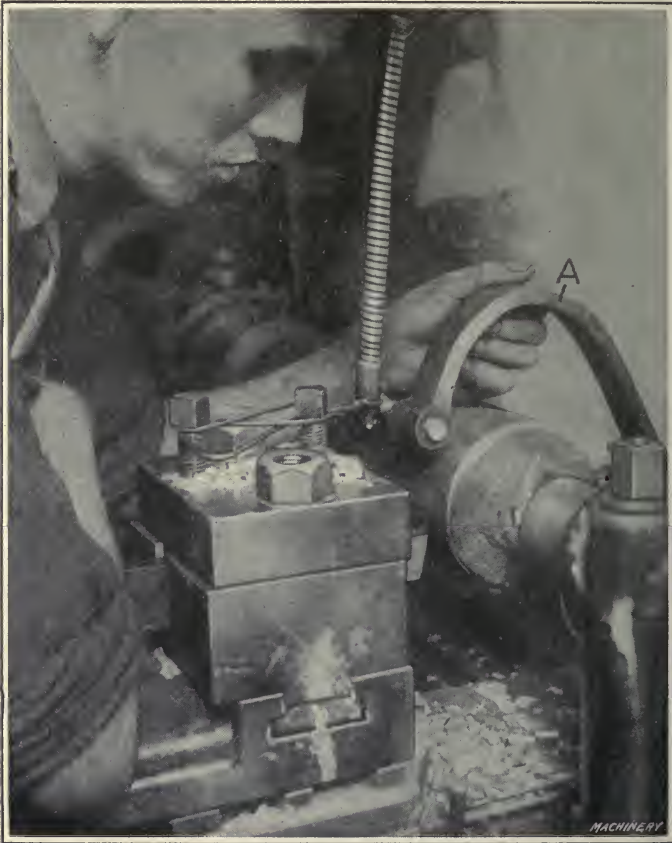

Fig. 74. Facing off Closed End of Forging to Length

Facing Off Closed End and Gaging for Length. — After centering, the closed end of the forging is faced off to the required length, as shown in Fig. 74, the forging being held on an expanding air-operated mandrel of the type shown in Fig. 73. The desired length is secured by a swinging tool-setting gage *A* held in a bracket fastened to the bed of the

lathe. In facing, from $\frac{1}{2}$ to $\frac{7}{8}$ inch of stock is removed; the work is rotated at 70 surface feet per minute and the feed is by hand. The production is six shells per hour.

The next operation consists in gaging the trimmed forg-

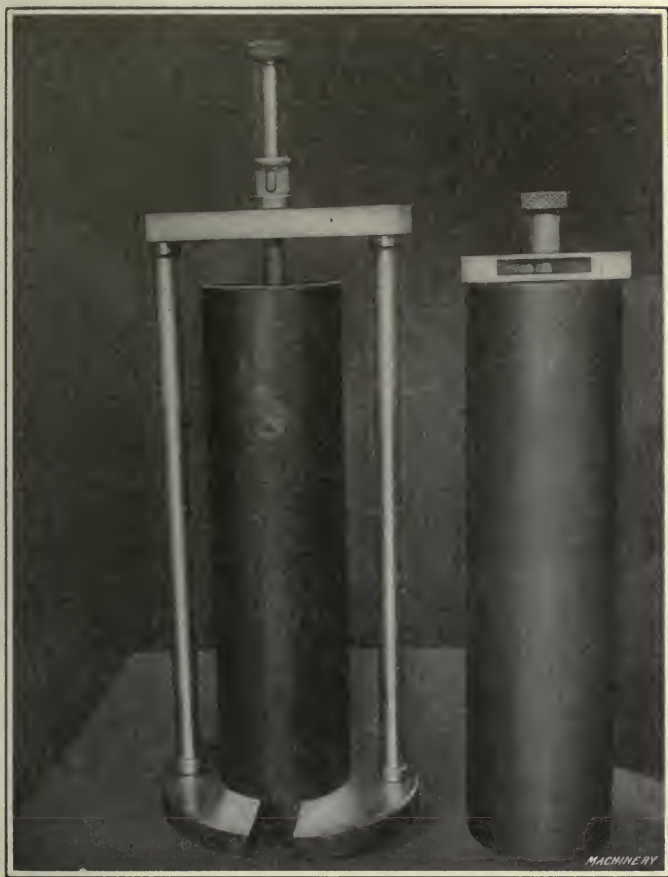

Fig. 75. Gaging Total Length of Trimmed Forging Prior to Turning

ings for over-all length, as shown in Fig. 75. The gage used consists of a plate, two pillars, and a cross bar. The plate has a slot so that the teat on the end of the shell does not interfere with the correct measurement of the over-all length. The gage used in testing the length of the shell

after cutting off the open end is also shown at the right. The allowable limit on length is 4 millimeters.

Rough-turning External Diameter.—The rough-turning of the external diameter is accomplished on a “Lo-swing” lathe as shown in Fig. 76. Two tools are used for this operation and remove about $3/16$ inch of stock from the

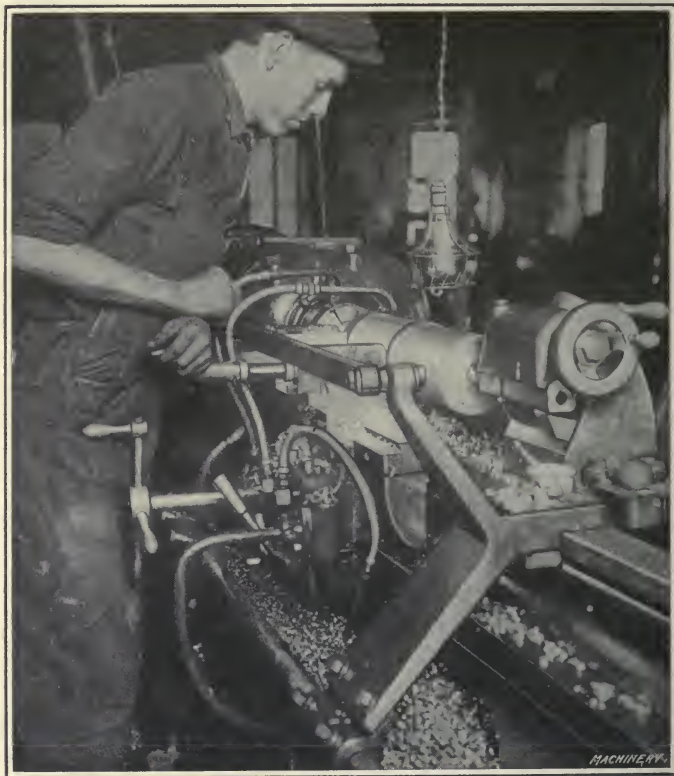

Fig. 76. Rough-turning External Diameter In a “Lo-swing” Lathe

diameter. One tool starts at the center of the forging while the other works from the closed end, so that the time required to turn the entire length of the shell is only equal to that which would be necessary to turn one-half the length with one tool. For this operation, the shell is held on an expanding mandrel of the type shown in Fig. 73.

The first cutting tool turns straight for a short distance until it approaches the nose, when it is backed out to enlarge the shell at that portion where it is nosed-in. The shells are turned in this operation to within 2 millimeters (0.0787 inch) of the finished size, the remainder being left

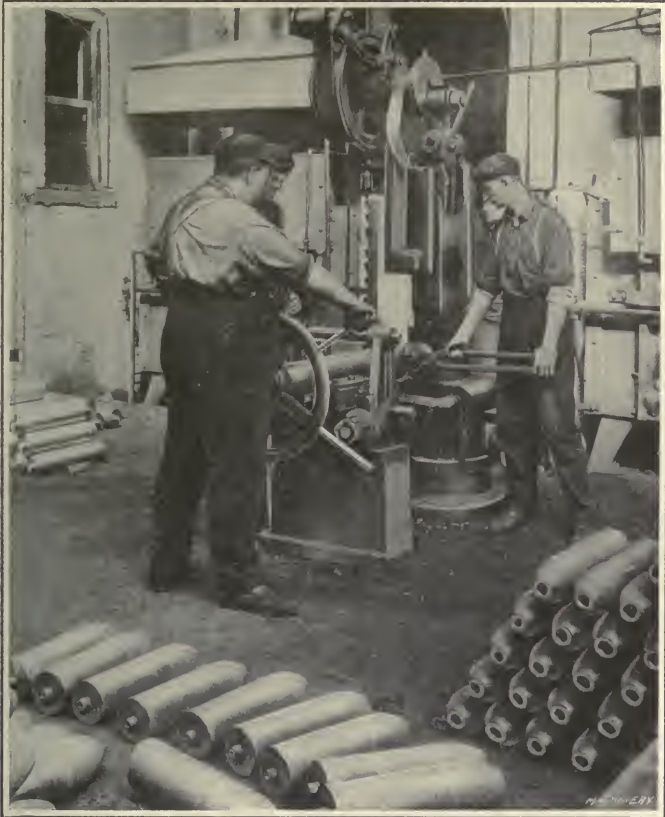

Fig. 77. Nosing-In Open End of Shell in a Beaudry Hammer

for grinding. The test for diameter is then made with a set of Johansson gages, after which the shell is heated for nosing-in. The production is four per hour.

Nosing-in Open End and Heat-treating.—For nosing-in, the shell is heated for a distance of six inches back from the open end in the Frankfort furnace shown in the back-

ground in Fig. 77. The shells are left in the furnace for thirty minutes and heated to a temperature of 1600 degrees F. (about 870 degrees C.). The furnace is heated by natural gas, and holds ten shells at one time. The nosing-in operation is accomplished in a 500-pound Beaudry hammer, as shown in Fig. 77. For this work four men are required. One rotates the shell on its axis; another feeds the shell into the hammer dies, which are split and of the right shape; the third operates the hammer; and the fourth takes the nosed-in shell out of the hammer and brings an-

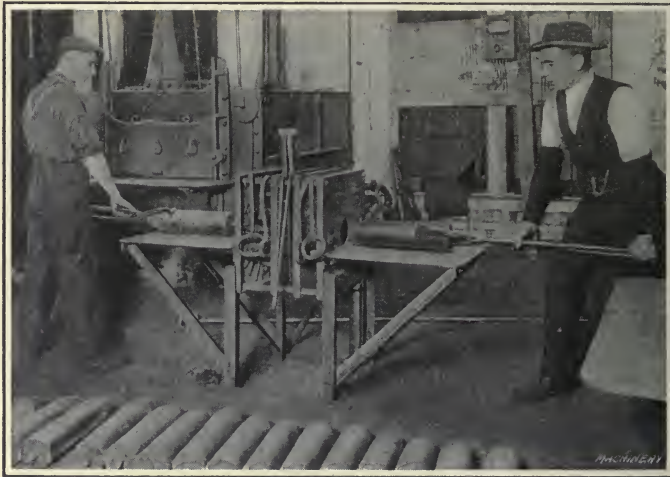

Fig 78. Heat-treating Furnace and "Brush" for removing Scale prior to immersing Heated Shell in Cooling Bath

other one to the power hammer ready for nosing-in. The nosing-in is started with light blows, so as to make the metal flow as evenly as possible; the blows are then increased in severity until the shell has received about twenty-five blows, which is ordinarily sufficient to complete the operation. An improved method, however, eliminates one man by rotating the shell on its axis by means of an air drill. The production is thirty per hour.

After nosing-in, the shell is taken to a lathe where it is gripped in a chuck, the nose bored out, and the end faced off to length. The next operation is heat-treating, the

heating being done in a Frankfort furnace of the type shown to the left in Fig. 78. The shell is left in the furnace for twenty-five minutes at a temperature of 1800 degrees F. (about 980 degrees C.). As soon as the shell reaches the desired temperature, it is quickly removed from the furnace



Fig. 79. Dipping French High-explosive Shells in Special Cooling Bath

and placed in the cooling bath, shown in Fig. 79 and in detail in Fig. 80. Formerly the brushing device shown in the foreground of Fig. 78 was used to remove the scale, but this has been found unnecessary. Each cooling bath accommodates only one shell and is so arranged that the water circulates inside the cavity as well as around the ex-

ternal circumference. The shells are left in the cooling bath for five minutes, after which tempering follows. The

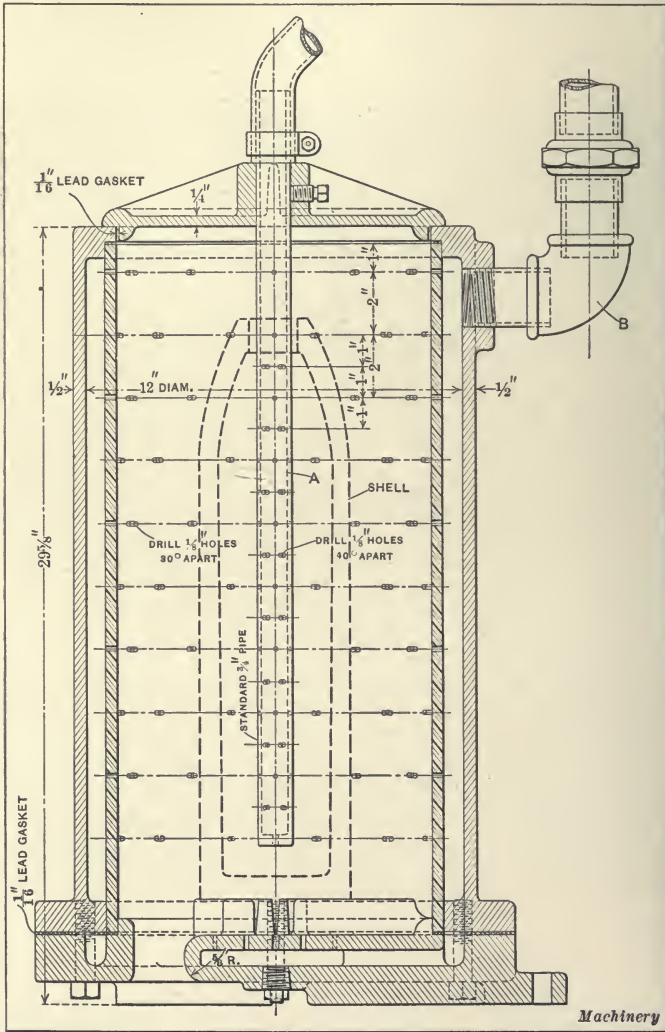

Fig. 80. Details of Cooling Bath shown In Fig. 79

quenching device shown in Fig. 80 does not provide for rotating the shell when cooling. An improved device incorporates a rotating table for revolving the shell and thus

obtaining a more uniform hardness. The tempering operation, which follows, is accomplished by heating the shell to 970 degrees F. (about 520 degrees C.) in a Frankfort furnace and then taking it out and allowing it to cool off in the air.

Inspecting for Hardness.— The final inspection for hardness is accomplished by means of a hydraulic testing machine, working on the Brinell ball principle, as is shown in Fig. 81. The ball used is 10 millimeters in diameter, and the pressure is 3000 kilograms (6613.8 pounds) for a period of fifteen seconds. The diameter of the impression



Fig. 81. Testing Hardness of French 120-millimeter High-explosive Shells

made with this ball must be 3.4 millimeters (0.1139 inch) ; this corresponds to a hardness on the Brinell chart of 321. After this testing operation, the shells are ready for grinding. This Brinell test factor indicates an ultimate strength of about 124 kilograms per square millimeter.

Pickling and Drying Partly Machined Shells.— After heat-treatment and testing for hardness, the shells are pickled to remove the scale formed in heat-treating, and dried before any further machining operations are performed on them. For pickling, the shells are placed, open end up, in a wooden rack and are immersed for forty-five

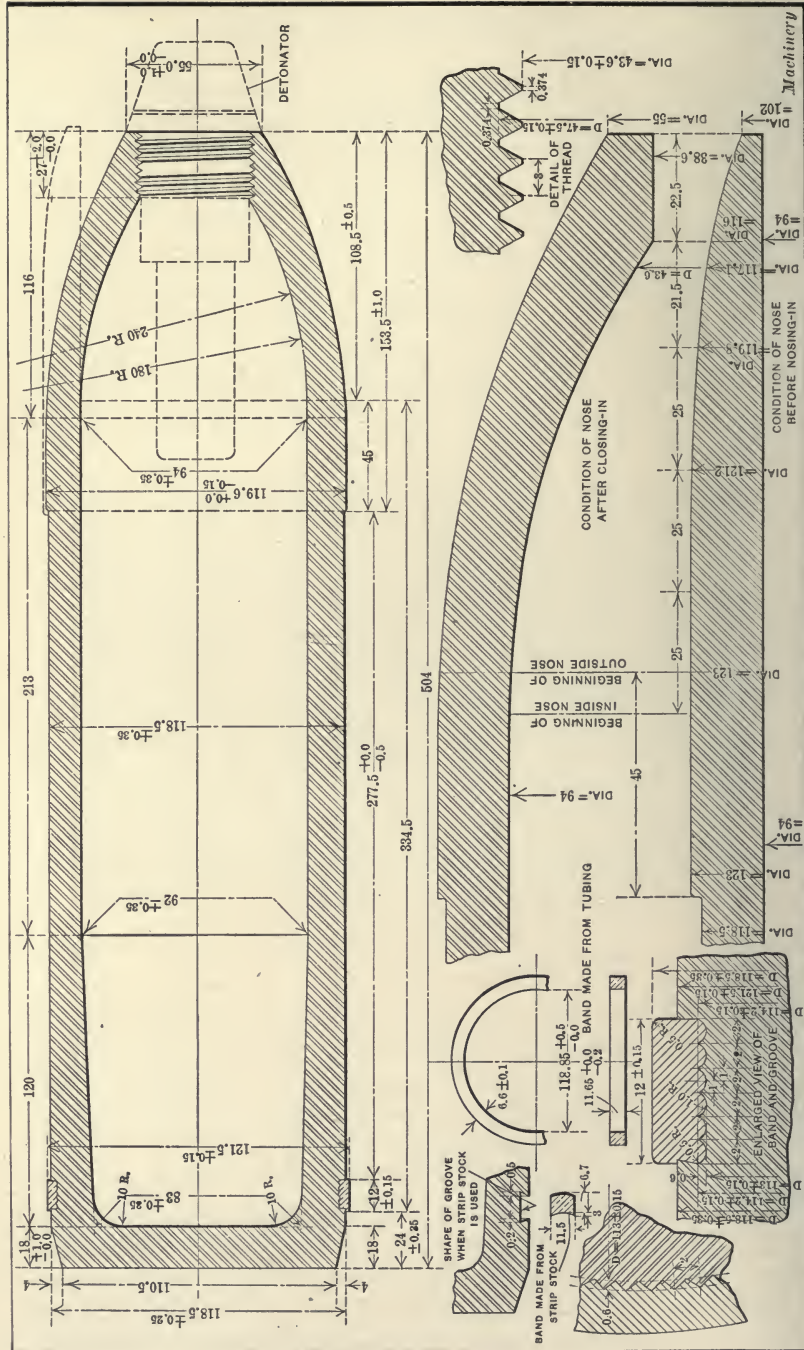

Fig. 82. Illustration showing French 120-millimeter High-explosive Shell, giving Finished Dimensions and Limits

Machinery

minutes in a bath consisting of ten parts water to one part sulphuric acid, and when lifted out are tipped so that the pickling solution runs out quickly. After immersing in the acid bath, the shells are washed in a solution of strong lime-water, then in clear running water, and then dried in a coke furnace, which is heated to 400 degrees F. (about 200 de-



Fig. 83. Boring and threading Open End of Shell on Jones & Lamson Single-spindle Turret Lathe

grees C.). This furnace is 24 inches wide, 12 inches high, and 48 inches long, and is tilted from the floor so that the shells, when fed in at one end, roll down and out of the other. It holds ten shells, which are left in it for forty minutes, after which they are taken out and allowed to cool in the air.

Boring and Threading Nose End.—Following the pickling of the partly machined shell, the first operation consists in recentering the base end, which is done on a Williams Tool Co. cutting-off machine that has been fitted up for centering. Here a light cut is taken to true up the center; the time required is about ten seconds per shell.

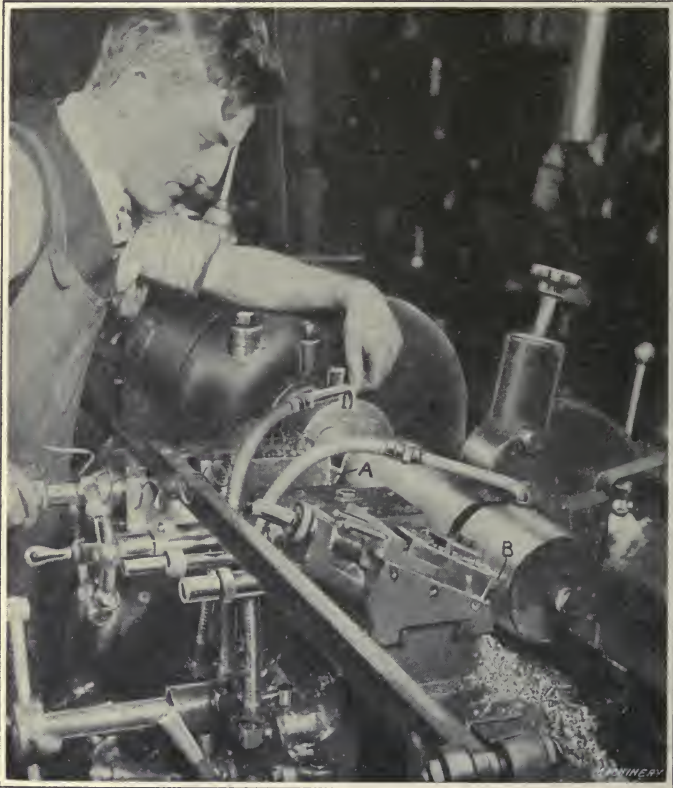

Fig. 84. Finish-turning External Diameter in a "Lo-swing" Lathe at the Rate of Four Shells per Hour

Following this, the shells are taken to the Jones & Lamson turret lathe shown in Fig. 83. For this operation, the work is held in a "Whiton" chuck and supported by a three-roll steadyrest. The operation consists in rough-boring the hole in the nose, finish-boring hole with an expanding bor-

ing-bar, reaming to 43.6 millimeters in diameter, rough-tapping with Murchey collapsible tap, finish-tapping with Murchey tap. For boring, the work is rotated at 50 surface feet per minute, and for tapping at 30 feet per minute. The production is seven shells per hour from each machine. The shells are now removed from the chuck and the thread finished to exact size by means of a master tap; this is really an inspection operation. The shells are then washed in a steam bath to remove all the oil and grease and are then dried thoroughly. Hardened center plugs are afterwards

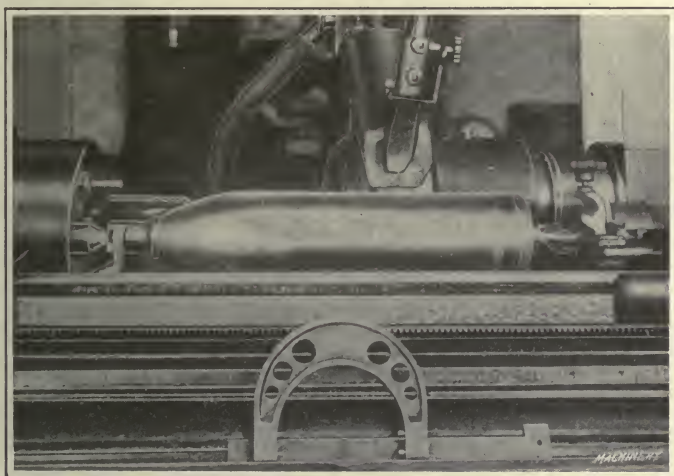

Fig. 85. Grinding Body of Shell on Norton Plain Grinding Machine

screwed into the open end of the shell to serve as a center point when grinding and turning the external surface in subsequent operations.

Finish-turning External Diameter of Shell.—The finish-turning operation is done on the “Lo-swing” lathe shown in Fig. 84. Here two tools are used to finish the straight portion; and when these have traveled about 6 inches on the shell, a third tool *A* turns the radius on the nose. Another tool, not shown, turns the band groove to width and depth, then an under-cutting tool finishes the under-cut, and finally the groove is knurled. The last operation is to bevel the

closed end with tool *B*. When a copper ring is used for the rifling band, only one side of the groove is dovetailed, but when a copper strip is used, both sides must be dovetailed. For the various turning operations, the work is rotated at a surface speed of 50 feet per minute, and the feed for the external straight turning is 0.020 inch per revolution. The production is four shells per hour.

Grinding External Diameter. — In the grinding operation

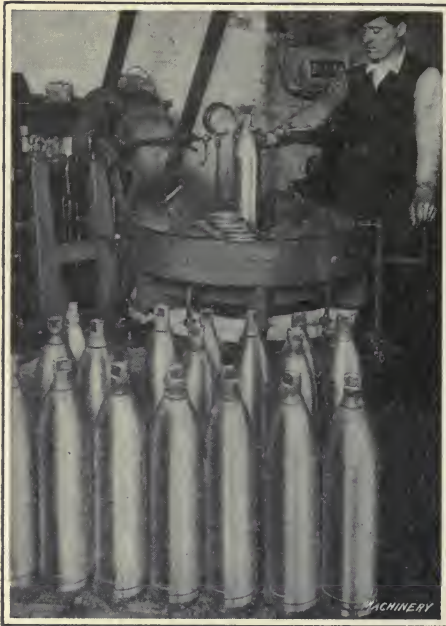

Fig. 86. Pressing on Copper Driving Band in a West Tire Setter Co. Banding Press

that follows finish-turning and illustrated in Fig. 85, about from 0.020 to 0.030 inch of material is removed from the diameter of the shell. The machine is a Norton plain grinder carrying a Norton alundum 20-inch diameter by 2-inch face wheel, grain 46, grade M, rotated at 1275 R. P. M. The grinding is done only on the straight portion, starting at a short distance from the base end, and proceeds straight until the enlargement near the nose is reached.

The wheel is then backed away from the work the required distance, and the straight portion finished on the nose to the point where the radius merges. Owing to the length of the work, the traverse method of grinding is used. The wheel is trued up after grinding every three shells. The production is eight shells per hour from each machine.

Pressing On and Turning Copper Bands. — When the copper band is of the ring type, the pressing on is done in a West Tire Setter hydraulic banding press, as shown in

Fig. 86. The inside diameter of this band is slightly larger than the external diameter of the shell, and is located in the correct position by means of the compressing dies, six of which are held in the machine. It requires from two to three squeezes to finish the pressing, and the production is twenty shells per hour. Before pressing on, the copper



Fig. 87. Turning Copper Driving Band



Fig. 88. Weighing French 120-millimeter High-explosive Shell

rings are heated to a dark red, then dipped in water and cooled to the temperature of the surrounding atmosphere. Following pressing on of the band, the shells are taken to a 16-inch engine lathe, as shown in Fig. 87. The first operation is to take a rough cut over the external diameter of the copper band with a turning tool, after which a form



Fig. 89. Gaging External Diameter and Thread In Nose



Fig. 90. Gaging Contour of French 120-millimeter High-explosive Shell

tool finishes the copper band to shape and diameter. The production is twenty per hour.

After turning the copper band, the center projection is cut off the closed end of the shell on a Williams Tool Co. cutting-off machine at the rate of twenty-four per hour. The center plug in the open end of the shell is also removed, leaving the shell in a suitable condition for weighing and inspecting.

Inspection. — The first inspection is for weight as shown in Fig. 88. The correct weight is 16 kilograms, 750 grams,



Fig. 91. Gaging Angle on Base End of Shell

and the tolerance is ± 200 grams (35 pounds, 6.97 ounces, ± 7.05 ounces). The first gaging test made is that for "bulge diameter." In this test, illustrated in Fig. 89, two ring gages are used. The diameter over the bulge is 119.6 millimeters plus 0.00 millimeter, minus 0.15 millimeter. The "go" size must pass over the bulge, whereas, the "not go" size must stop on it, as shown. The next test is made over

the copper band; for this, snap gages of the horseshoe type are used. The limits are 121.5 millimeters plus 0.15, minus 0.00 millimeter. The third test is for over-all length, which is accomplished by means of a gage similar to that illustrated in Fig. 75. With a gage of a similar kind, the thickness of the closed end is measured from the nose. The next test is the diameter across the nose. This is made

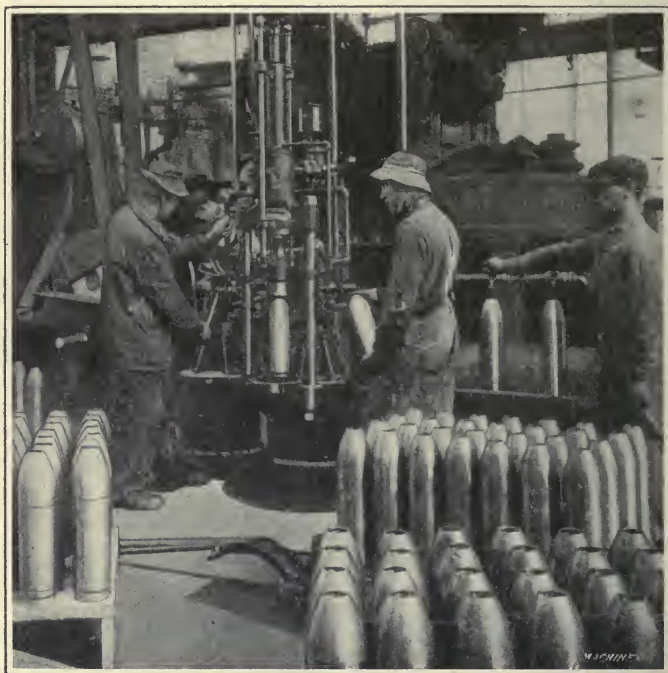

Fig. 92. Testing for Strength in a Metalwood Hydraulic Press

with a flat gage and the limits are 55 millimeters plus 1.0, minus 0.00 millimeter. The master thread gage is next screwed into the nose to see if the thread is correct; after this the plug is tried for diameter at root of thread; these gages are all shown in Fig. 89. The next test is for the contour, which is made as shown in Fig. 90. A long flat gage that covers the entire length of the shell and also the contour at all points, when laid across the shell as illus-

trated, shows whether the shell has been turned and finished to the correct shape or not. Every point on the shell must check up to the templet. The next test consists in testing the angle at the closed end of the shell, as shown in Fig. 91. The maximum diameter is 118.5 plus 0.25 millimeter, and the minimum diameter is 110.5 millimeters.

Testing for Concentricity.—The next important test is for concentricity. In this test, as illustrated in Fig. 93, a

counterweight gage *A* having two arms and counterweighted on one end is fastened to the base end of the shell. The shell rests on hardened strips fastened to a cast-iron plate and is located at right angles to the hardened pieces by pins driven into the plate. It is then rolled over and must balance perfectly when the gage is in place. The heavy side of the shell is first found by rotating it on the parallel ways and then the weight is located on



Fig. 93. Gaging Concentricity of Shell

the light side. The moment of rotation must equal the amount of eccentricity from the center of gravity times the weight of the shell, as worked out from the formula:

$$WS = PR$$

in which *W* = weight of shell;

P = weight used on stem of gage;

R = distance from center of shell to center of weight *P*;

S = maximum eccentricity from center of gravity,
which on this size of shell is 0.7 millimeter.

As W , P , and R are known, S may be solved in the formula given. If S is found to be 0.7 millimeter or less, the shell is passed. If, however, S is found to be more than 0.7 millimeter, the eccentricity is too great; P and R may be standardized for the maximum eccentricity, thus avoiding calculating.

Testing French High-explosive Shells for Strength.— Every shell after machining and inspection is tested for strength in a hydraulic press of the type shown in Fig. 92; this particular machine is made by the Metalwood Mfg. Co., Detroit, Mich. Previous to testing, the shells are filled with water and placed in the machine. A pressure equal to 650 kilograms per square centimeter (9500 pounds per square inch) is then maintained on every shell for about ten seconds, after which the shell must show no leaks nor cracks. Following the testing operation, the shell is examined for cracks, etc., and is then inspected by French officials. One shell in every hundred is given every test by an official. The last operation consists in greasing and packing the shells ready for shipment.

CHAPTER VII

MACHINING BRITISH HOWITZER SHELLS

THE British, 4.5-inch, howitzer, high-explosive shell, shown in Fig. 94, starts with a cast billet about three feet long, which is subsequently cut into shorter lengths and forged to approximate shape. There are about thirty-two machining and inspection operations on this shell, and the average time required to produce one shell complete and ready for shipment is one hour, thirty-six minutes. The

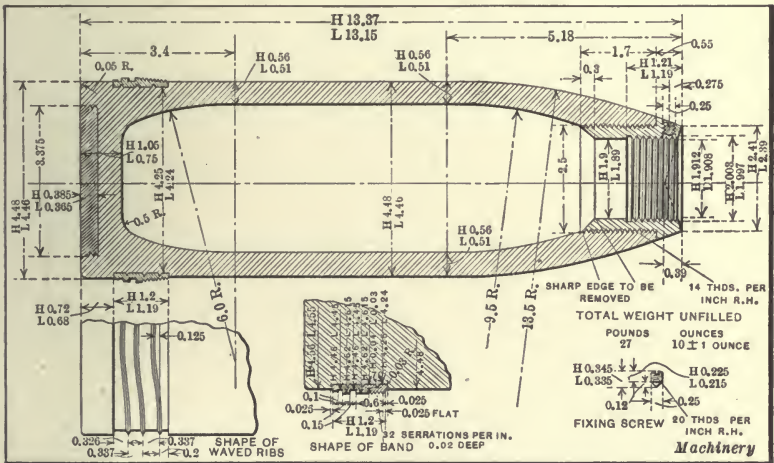

Fig. 94. British 4.5-Inch Howitzer High-explosive Shell

equipment used for this purpose, however, was not originally laid out for handling this work; in fact, the only special equipment purchased to turn a car shop into a shell plant was small tools and a few attachments for engine lathes.

The order of the various operations is as follows: The shell is marked off and the amount of material to be removed from each end is indicated. The open end is then

cut off, as shown in Fig. 95, in an axle lathe that has been fitted up for this work. This axle lathe is of the double-head type, so that two men can work on one machine. The production is 250 in ten hours. The wall of the forging is about $13/16$ inch thick, the cut-off tool $3/8$ inch wide, and the speed 15 R. P. M.; the cutting tool is fed in by hand.

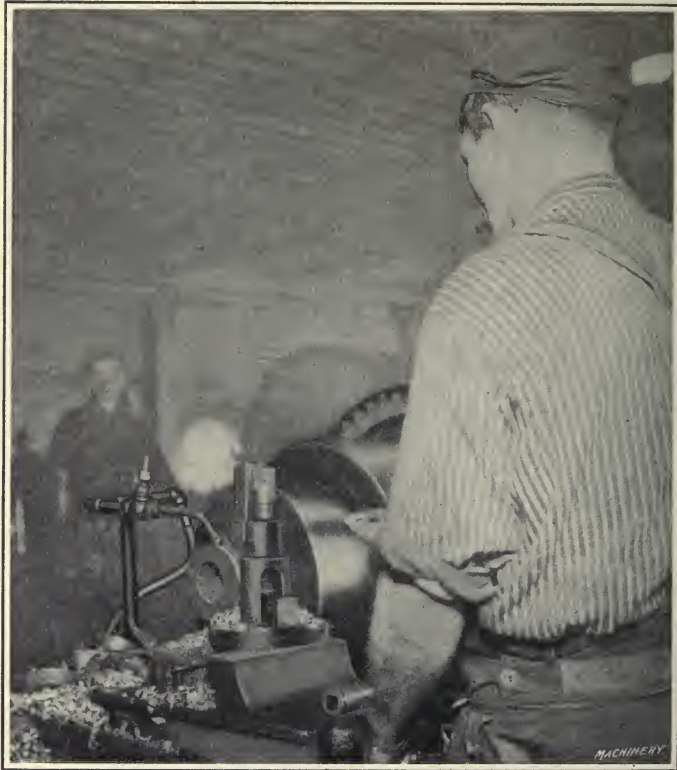

Fig. 95. Cutting off Open End of Forging

Facing and Rough-boring.—The second operation consists in facing off the closed end in a boring mill where twenty-four of the forgings are held in a fixture; two tools are used. The depth of cut is $1/4$ inch and the feed $1/16$ inch per revolution. The table of the machine is operated at 120 R. P. M. and the production is about 220 in ten hours.

The third operation consists in rough-boring the interior to $3\frac{3}{8}$ inches in diameter in a four-spindle rail drill operated by two men, as shown in Fig. 96. The hole is $9\frac{3}{8}$ inches deep and is finished in one cut. A cutting lubricant known as "Mystic," made by the Cataract Refining Co., is used to keep the tools cool. The shell being rough-bored is held

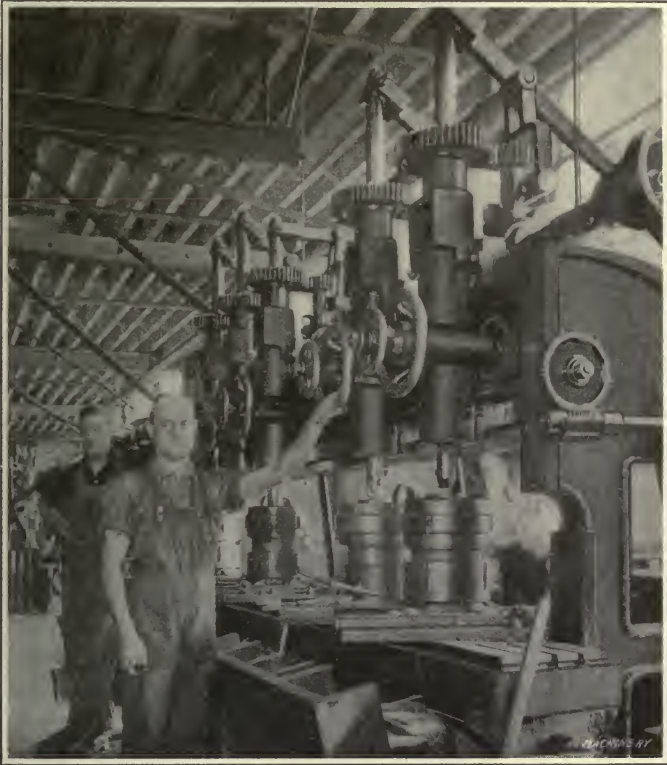

Fig. 96. Boring out Cavity of 4.5-Inch Howitzer High-explosive Shell

in a spring collet chuck attached to a slide that works in guides located on the table. The boring tools are rotated at 50 R. P. M. and the spindle moves down with a speed of about $1/16$ R. P. M. The production is 240 in ten hours.

The fourth operation consists in centering the base end in an 18-inch engine lathe. The forging is held on an ex-

panding mandrel and the center hole in the base end is first drilled and then centered with a centering tool. The production is 400 in ten hours.

Rough-turning.— The fifth operation is rough-turning in an axle lathe. The shell is again held on an expanding mandrel and turned up for a distance of $9\frac{1}{4}$ inches from the base end. The feed is $\frac{3}{32}$ inch per revolution and the depth of cut is $\frac{7}{32}$ inch. The speed of the work is 50 R. P. M. The production is 140 in ten hours.

Spot-drilling, Bottoming, and Finish-boring.— The sixth

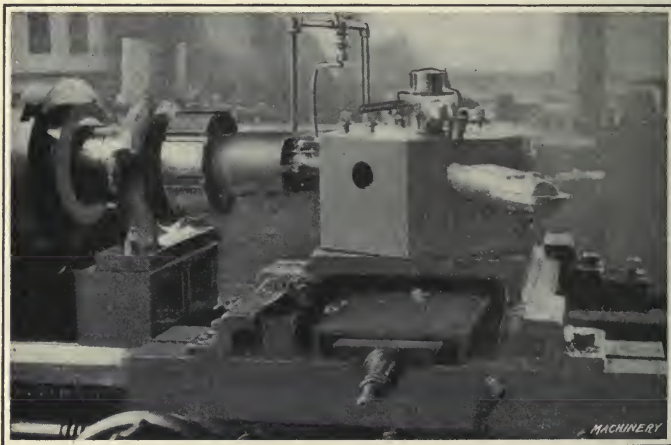

Fig. 97. Finish-boring, reaming and facing 4.5-Inch Howitzer High-explosive Shell

operation consists in spot-drilling on the inside with an end-cutter on a 28-inch, upright, drilling machine. The work is held in a collet chuck and about $\frac{1}{4}$ inch of metal is removed. The spot-drilling tool is rotated at 140 R. P. M., and is operated by hand feed; the production is 300 in ten hours. The seventh operation consists in hogging out the pocket at the bottom with a form cutter, held in a boring-bar in a wheel boring lathe of the vertical type. This tool is rotated at 48 R. P. M. and just cuts at the bottom; it is operated by hand feed. For this operation the forging is held in an expanding collet chuck and the production is sixteen pieces per hour.

The eighth operation consists in chamfering on a wheel boring lathe with a tool that chamfers the inside of the shell at the mouth only. This tool is rotated at 48 R. P. M. and chamfers for a distance of about $1\frac{1}{2}$ inch down into the shell, enlarging the shell from $3\frac{3}{8}$ to $4\frac{3}{16}$ inches. The ninth operation, as shown in Fig. 97, consists in finish-boring the inside of the shell and finish-chamfering the mouth. The operation is to bore and face with an end facing tool that is located from the bottom, then finish the pocket at the bottom and chamfer. The machine used is

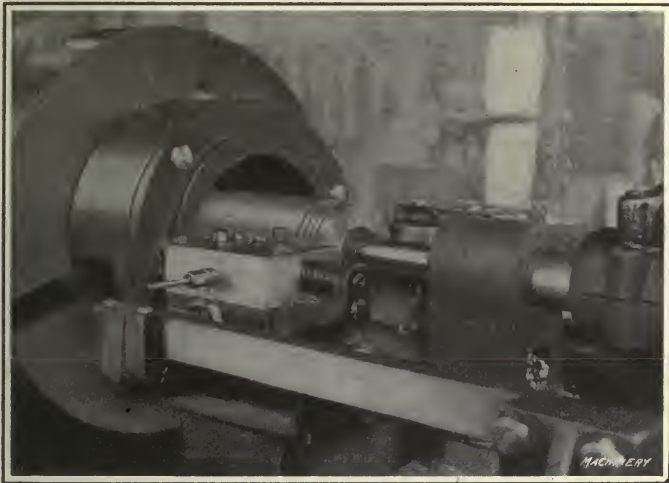

Fig. 98. Waving and Under-cutting Band Grooves

a Bertram 26-inch engine lathe provided with a turret, and the shell is held in an expanding chuck and rotated at 80 R. P. M. The cuts vary from $\frac{1}{32}$ inch to just cleaning up, and the production is eighty in ten hours.

Grooving and Waving.— The tenth operation is finishing the nose on the outside diameter with two tools. The first takes a straight roughing cut, the second turns the radius, and a third tool held in the same toolpost finish-chamfers the end. The machine used is a New Haven, 24-inch, engine lathe. The center on the tailstock is brought in to support the work, which is also held in a three-jawed chuck.

The work rotates at 60 R. P. M. and the production is 220 in ten hours. The eleventh operation consists in taking a finishing cut over the base, roughing out the band groove, and finishing the external diameter back of the band groove, on a New Haven, 24-inch, engine lathe. The production is twelve per hour. The work is rotated at 60 R. P. M., and one turner and one form tool are used.

The twelfth operation is waving and under-cutting in a New Haven, 24-inch, engine lathe, to which has been applied a Bertram waving attachment, as shown in Fig. 98. The work is held in a chuck of the three-jaw type and is supported at the opposite end by the tailstock center. The

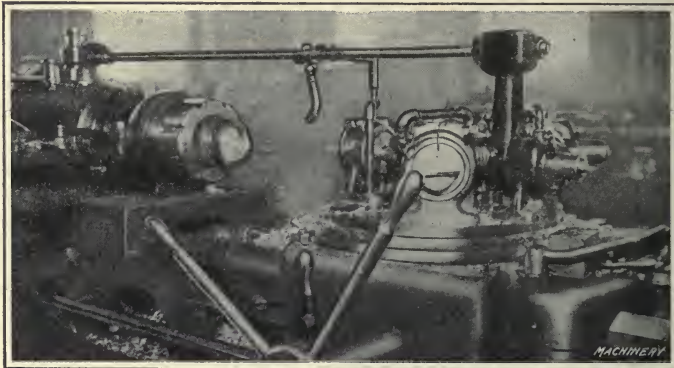

Fig. 99. Boring out Closed End of Shell for Gas Plug and threading

waving tools are operated by a cam on the face of the chuck. The work is rotated at 40 R. P. M. and the production is twenty-five per hour.

Nosing-in, Boring, and Threading Nose. — The thirteenth operation is nosing-in, which is done in a Williams & White bulldozer. The shell is heated in a furnace to a white heat and is nosed-in in one blow. It requires three men to handle this operation; one looks after the furnace and two after the machine. The production is 400 in twelve hours. After cooling, the shell is brought back to the machining department where the fourteenth operation is performed. This consists in boring out the closed end of the shell for

the gas plug and threading on a Jones & Lamson, single-spindle, flat-turret lathe, as shown in Fig. 99. The operations are: Drill hole $1\frac{3}{8}$ inch in diameter, hog out with a flat cutter, under-cut and face with a combination under-cutting and facing tool, and thread with a Jones & Lamson regular chasing attachment. The work for all operations except threading is operated at 30 surface feet per minute, and the production is ten per hour.

The fifteenth operation consists in machining the nose on a Reed, 20-inch, engine lathe, provided with a turret attachment, shown in Fig. 100. The operations are: Bore, taking a $1/16$ -inch cut at a speed of 50 R. P. M., and face off to length, rough out inside radius with a boring tool,

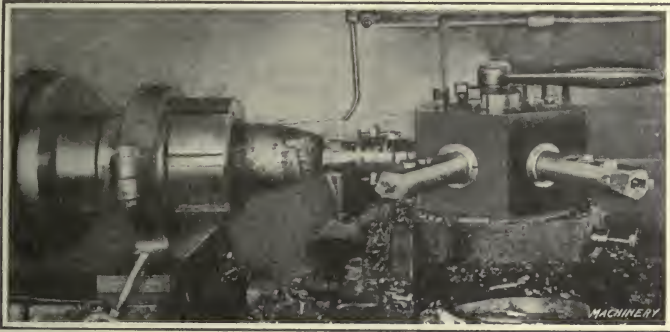

Fig. 100. Boring, facing and threading Nose End of Shell

feeding by hand; finish inside radius to shape with a form cutter; and tap for a distance of 2 inches with a Murchey collapsible tap. The production is nine and one-half per hour.

Finish-turning. — For the sixteenth operation a center plug is inserted in the open end of the shell. The external diameter is then turned all over in an 18-inch Canadian Machinery Corporation lathe. As shown in Fig. 101, two cutters, which are held in the toolpost, are used for finishing. The cut is about $3/64$ inch deep, and the operation of the tool-slide is controlled by a forming bar at the rear. The feed of the tools is $1/32$ inch per revolution; and the speed, 100 R. P. M. The production is nine per hour.

Miscellaneous Operations.—The seventeenth operation is sand-blasting the inside with an air nozzle inserted in the shell; the production is about 200 in ten hours. The eighteenth operation is preliminary inspection. The nineteenth is to screw in the base plug, and, at the same time, wrench off the projection with a heavy wrench. The twentieth operation is to face off the plug and round the edges of the base on a Canadian Machinery Corporation 18-inch engine lathe. The operations are: Take a roughing cut across the base, roll in plate with a plain roller, and take a finishing cut across the base. For these operations the feed



Fig. 101. Turning External Diameter to Size and Shape

is by hand and the cuts vary in depth from $1/16$ to $3/16$ inch. The speed of the work is 120 R. P. M., and the production is fifteen per hour.

The twenty-first operation is stamping with hand stamps, the work being held in a fixture while this operation is being performed. Sixteen stamps are necessary and the production is 295 shells in ten hours. The twenty-second operation is re-tapping the hole in the nose of the shell with a Murchey tap, the shell being held in an Acme single-head threading machine, carrying a chuck instead of a die-head. The production is twenty-five per hour.

The twenty-third operation is screwing in the brass nose

bushing by hand, holding the shell in a fixture. The twenty-fourth consists in turning the brass socket in a McDougal, 20-inch, engine lathe, one cutting tool being used; the production is twenty per hour. The twenty-fifth operation is cleaning out the shell with benzine and then varnishing it with a brush. The shell is laid down on the bench, rolled back and forth by the operator, and the interior varnished with a brush shaped like a large toothbrush. Two men are employed for this operation and the production is 400 in ten hours. The twenty-sixth operation is baking the

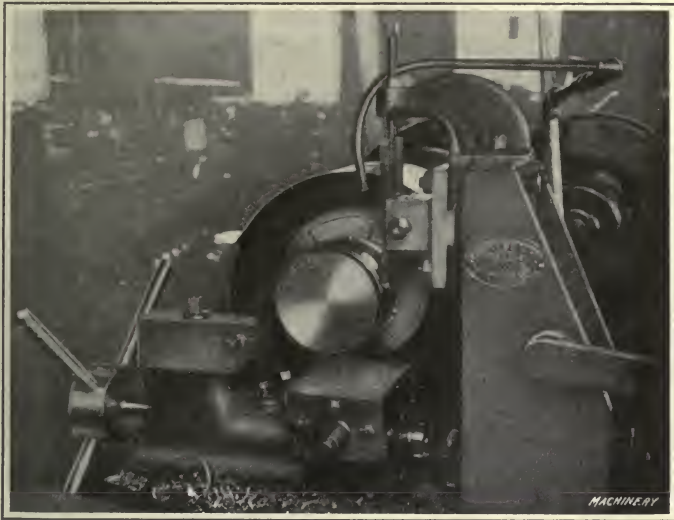

Fig. 102. Turning Copper Driving Band

varnish on the shell in an oven, which is heated to 300 degrees F. (about 150 degrees C.). This oven is kept at a constant temperature and the shells are left in for eight hours. They are then taken out and allowed to cool in the air. As the furnace holds 240 shells, the production is 240 in eight hours.

Pressing on and Turning Copper Bands. — The twenty-seventh operation is pressing on the copper band, which is done in a special banding machine having four hydraulic cylinders. The production is 225 in ten hours. Turning

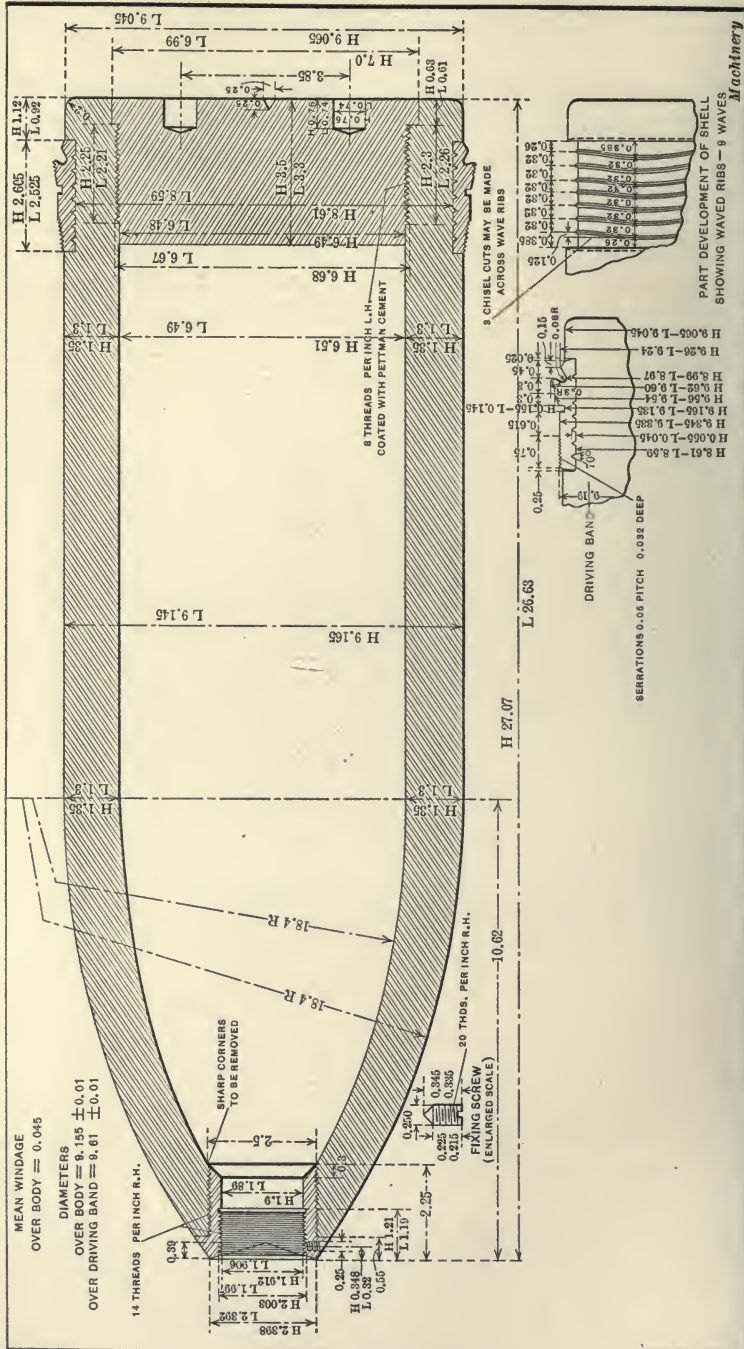

Fig. 103. British 9.2-inch Howitzer High-explosive Shell

the copper band is the twenty-eighth operation; this is done in a Walcott & Wood, 22-inch, engine lathe, equipped with a Lymburner Ltd. band turning attachment, as shown in

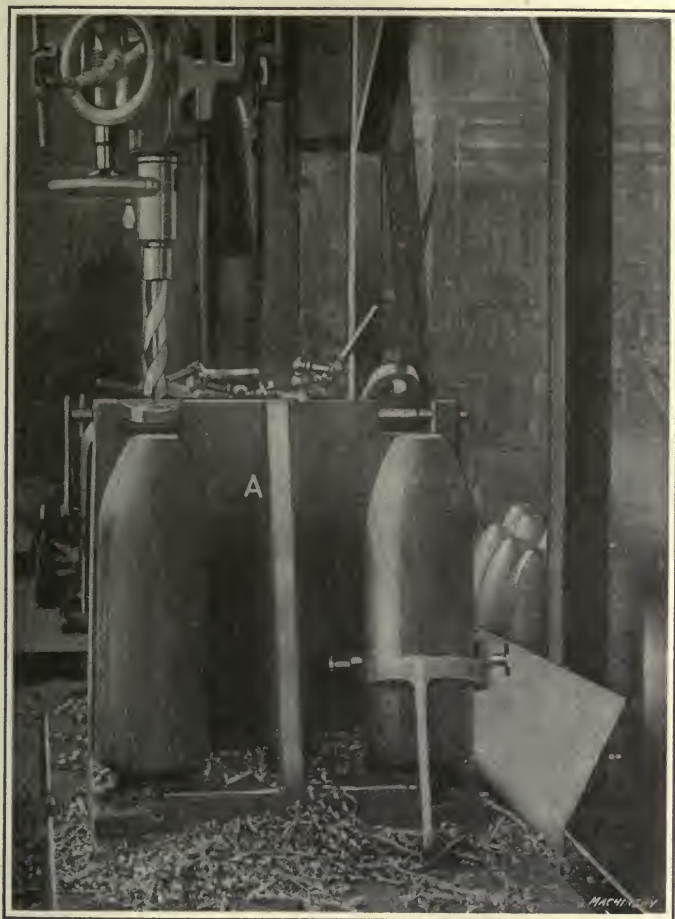

Fig. 104. First Machining Operation on British 9.2-inch High-explosive Shell Forging—drilling Hole in Nose and facing

Fig. 102. This attachment carries two forming tools, one on the front and one on the rear of the cross-slide. The operations performed are: Rough-turn band with a tool on the top of the slide, operated by a turnstile at the front;

rough-form band to shape with a form tool; and finish band with a forming tool held on a special attachment at the rear of the machine and operated by a separate handle. The work is rotated at 250 R. P. M. and the production is twenty-five per hour.

The twenty-ninth operation is the final inspection. The thirtieth, applying the first coat of paint, the base of which is white lead; the thirty-first, applying the second coat of yellow paint. After drying, the shells are again inspected and packed ready for shipment, the plug, of course, being screwed into the nose to prevent foreign matter from getting into the cavity of the shell, and also to protect the threads in the nose from bruises. The plug is retained in the shell until it is removed for loading; it is then replaced and not removed again until the shell reaches the field of operations, where it is taken out and the detonating fuse substituted.

Machining 9.2-inch British Howitzer Shells. — Starting with the finished forging, which is made with a closed-in nose and has been carefully annealed, the first machining operation on the 9.2-inch British, howitzer, high-explosive shell shown in Fig. 103 consists in drilling a two-inch hole through the nose and in facing off the nose end of the shell until the required length is obtained. These operations are performed on a six-foot, radial, drilling machine, as shown in Fig. 104, using a two-station jig that enables one side to be loaded while the machining operations are being performed on a forging located on the other side. The jig A is in the form of an angle-plate, and the radial arm of the machine is moved to bring the tool in line with the work. The drilling is done at a cutting speed of from 60 to 65 feet per minute with a down feed of $1/64$ inch per revolution. The production is five and one-half shells per hour, one man operating the machine.

Cutting-off and Rough-turning Operations. — The next operation is cutting off the open end, which is done on a Pond 24-inch lathe. The forging is held in a "pot-chuck" (see Fig. 106), and is gaged from the end just machined. The surplus stock on the open end is cut off by means of a special carriage carrying two cutting-off tools, and oper-

ated by right- and left-hand screws, so that both tools are at work at the same time. The blades of the cutting-off tool are $\frac{3}{8}$ inch wide, and the surface speed of the work is from 70 to 80 feet per minute. One man operates two machines and cuts off seven shells per hour.

After cutting off, the straight portion of the shell is rough-turned. For this operation the shell is held on a mandrel that has two sets of expanding plungers and the work is done on a Pond 24-inch lathe. Two cutting tools are used and remove a total of $\frac{3}{4}$ inch on the diameter in

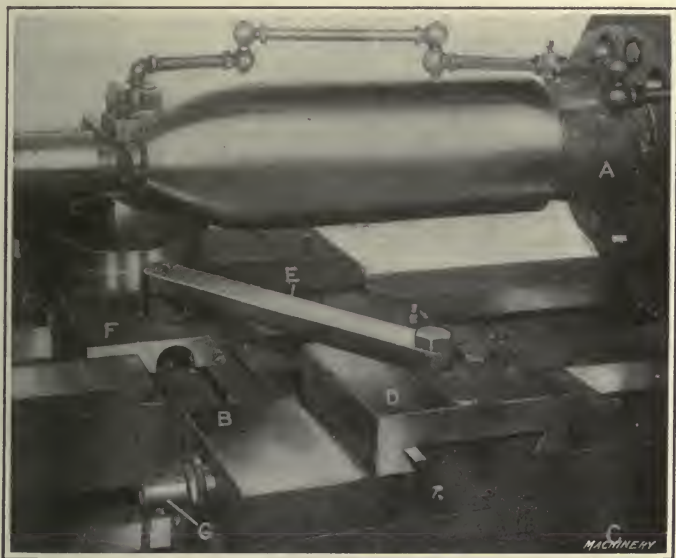

Fig. 105. Turning Radius on Nose on a 24-Inch Engine Lathe

one cut. Each tool removes $\frac{3}{8}$ inch, and works at a cutting speed of from 70 to 80 surface feet per minute. As the forgings vary somewhat, it is often necessary to take two cuts to finish. The longitudinal feed is $\frac{1}{8}$ inch per revolution of the work. At this setting, the nose of the shell is not touched; the next operation is the roughing of the nose to the required radius on a Pond 24-inch lathe, Fig. 105. The shell is gripped from the internal diameter by expanding mandrel A, fastened to the faceplate as shown.

Two cutting tools are used which are guided in the correct path by a simple but satisfactory device. This radius device comprises a special carriage *B* that is carried on a bracket *C* bolted to the bed at the rear of the lathe. Located on carriage *B* is a stationary slide *D* to which is bolted a link *E* that serves to connect the cross-slide *F* with the rear carriage. The cross-feed screw ordinarily used is removed so that the motion of the slide *F* in a radial direction is controlled by the link *E*. In operation, as the front carriage is fed toward the faceplate, the link *E* forces the

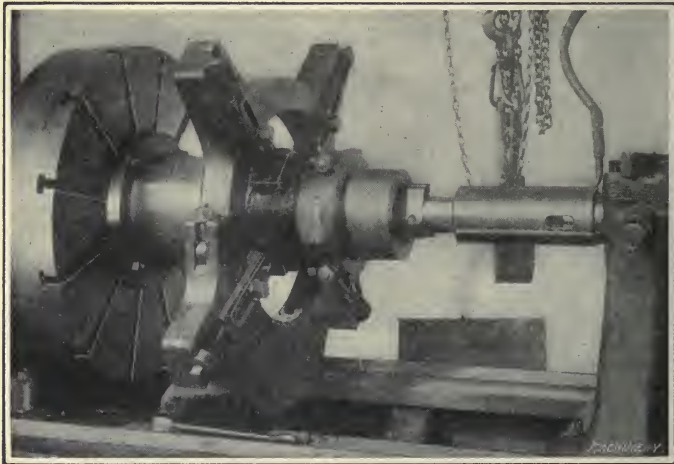

Fig. 106. Rough- and finish-boring Internal Diameter on a 36-Inch Engine Lathe

cross-slide *F* back and thus guides the cutting tools in a curved path. The correct starting and finishing points of the radius on the shell are obtained by adjusting the screw *G*. The production for rough-turning the straight diameter and nose is one shell per hour.

Boring, Counterboring, Facing, and Threading Operations.—The boring is performed on a Pond, 36-inch, heavy-duty lathe provided with a rack tailstock, as shown in Fig. 106. For machining, the shell is held in a “pot-chuck” clamped to the faceplate and is additionally supported by a steady-rest as shown. The interior of this chuck is made an

easy fit for the shell, which is held by contracting the split chuck by clamping bolts as shown. Two three-tooth boring reamers are used, one roughing and one finishing, which remove about $\frac{1}{2}$ inch from the diameter between them. The roughing reamer is provided with high-speed steel blades which are serrated to break up the chip, whereas the finishing reamer is provided with smooth blades of high-speed steel. The cutting speed of the reamers is from 74 to 78 surface feet per minute. The longitudinal feed is very coarse ($\frac{1}{2}$ inch per revolution) until the radius is reached,

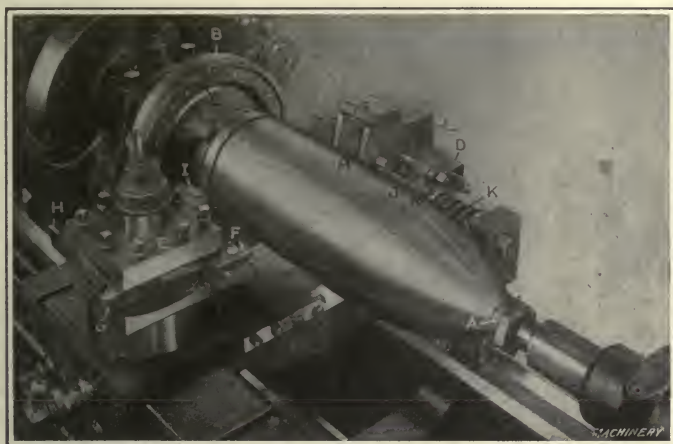

Fig. 107. Set-up on a 24-Inch Engine Lathe for machining Band Groove and cutting Wave Ribs

where it is reduced to $\frac{1}{32}$ inch per revolution. The production is one shell per hour.

Following the operation just described, a series of operations is performed on the nose of the shell on a Pond 24-inch lathe provided with a four-sided turret. The shell is held in a pot-chuck, but with the nose instead of the base end projecting. The operations are: Rough- and finish-bore opening, rough-face end, tap and finish-face end. The finishing cuts are taken at an average speed of 120 surface feet per minute and the feed is $\frac{1}{32}$ inch per revolution. The production is two shells per hour.

The reverse end of the shell is now machined, and, as in the previous operation, is held in a pot-chuck. The work is done on a Pond 24-inch lathe provided with a four-sided turret. The operations are: Face off base end, bore and counterbore, and chase thread for base plug. The cutting speeds are 120 surface feet, feeds $1/32$ inch per revolution, and production, one shell per hour.

Finish-turning, Grooving, Waving, and Assembling Base Plug. — The finish-turning on the external diameter is done on a Pond 24-inch lathe provided with a former plate, somewhat similar in design to an ordinary taper-turning attachment. One cutting tool is used and one cut finishes the work. The speed is 120 surface feet, and the feed $1/32$ inch per revolution. The production is two shells in three hours.

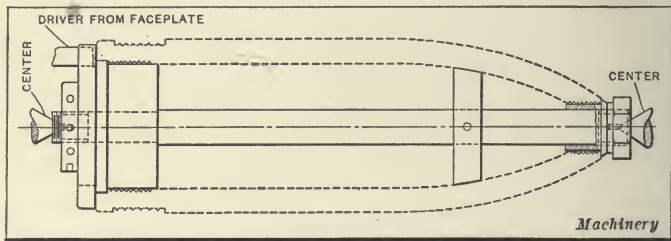

Fig. 108. Diagram showing Details of Construction of Mandrel used for holding Shell when performing Operation shown in Fig. 107

The shells are then taken to the Pond 24-inch lathe shown in Fig. 107, where the band groove is cut and the wave ribs produced. The shell is held on a special mandrel *A* (see Fig. 108 for details of construction) which is driven by a special faceplate *B*, Fig. 107, that carries the cam *C* used in oscillating the rear waving slide *D*. The lathe carriage is provided with a turret toolpost *E* carrying four tools that perform the following operations: Tools *F* neck at the limits of the band groove, tool *G* roughs out the groove to the top of the ribs, tool *H* under-cuts the edges of the groove, and tool *I* roughs out between the wave ribs. The wave ribs are produced by the special fixture *D* held on the rear of the carriage. This comprises a slide *J* which is oscillated by the cam *C* against the tension of a

spring *K*, and carries a tool-holder *L* that holds the waving tool *M*. Tool-holder *L* is adjusted for position by screw *N*. This fixture is operated by bringing the cross-slide forward and moving the carriage over until a roll (not shown) engages with the cam *C* that imparts the required oscillating movement to slide *J*. The band grooves are cut and ribbed at the rate of eighteen shells in ten hours. The base plug and nose bushing are put in by hand. Each plug is carefully fitted and cleaned, and is left partly screwed in place until such time as the loading of the shell is finished.

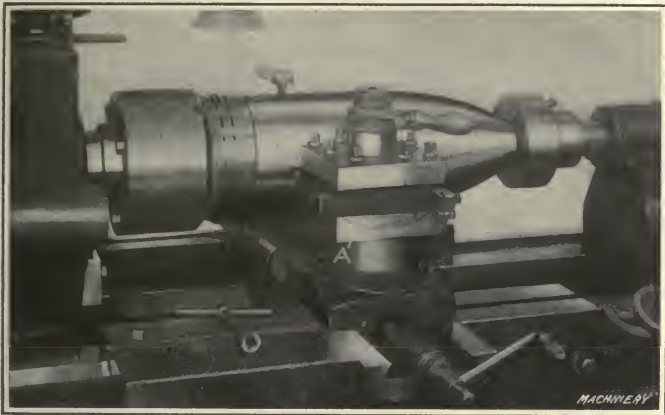

Fig. 109. Set-up for turning Copper Band to Shape on a 24-Inch Engine Lathe

Banding and Band-turning Operations. — The pressing on of the copper driving band is performed in a Dudgeon hydraulic banding press. The copper bands are heated to a bright red in a “Best” oil furnace, and when they have attained the correct temperature they are quickly removed and placed in the banding press. The shell is then placed in the press, the band being slipped over it and located by the dies in the correct relation to the groove. As the press is operated, six dies are forced in radially and compress the band into the groove. After the first squeeze, the shell is turned 30 degrees and given another squeeze. The production on this operation is about twenty shells per hour.

The copper band is turned on the Pond 24-inch lathe shown in Fig. 109. Here it is supported and driven from one end by a special driver *A*, Fig. 110, and is supported on the nose end by a revolving center *B*. The cross-slide carries a turret toolpost *A*, Fig. 109, holding four tools, which, in conjunction with a forming tool on the rear of the slide, rough- and finish-turn the band to shape. The production is three shells per hour.

Weighing, Cleaning, Varnishing, etc.— Upon the completion of the machining operations, the shells are weighed, the limit in weight being 10 ounces either way from the standard, which is 252 pounds. Working from the nose

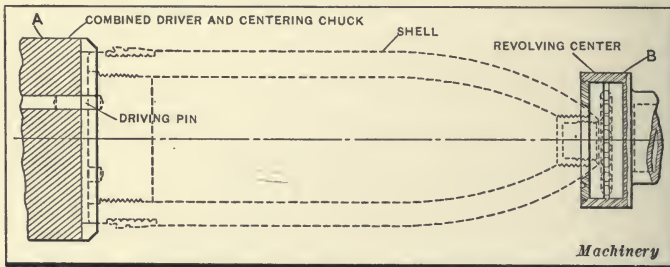

Fig. 110. Diagram showing Method of holding and driving Shell when performing Operation shown in Fig. 109

end, the shell is now washed out with soda water and then dried, after which a coating of Copal varnish is sprayed in with a Buffalo air-spray brush. The shell is swabbed outside, while hot, with a light machine oil and then baked for eight hours at a temperature of 300 degrees F. (about 150 degrees C.).

Because of their weight, these shells are too heavy to handle by hand, so light air hoists are located over each machine to facilitate handling. These hoists travel on a continuous track, which runs down the aisle of the shop between two rows of machines along which the shells are kept moving. Stamping, inspecting, etc. finish the operations on the shell, after which it is ready for packing and boxing.

CHAPTER VIII

MISCELLANEOUS TOOLS AND DEVICES FOR SHELL MANUFACTURE

BRITISH, 18-pound, high-explosive shells are made from bar stock, the usual method being to rough out the hole in a high-power drilling machine. Figs. 111 and 112 show an efficient method of accomplishing this operation. The machines used are Baker Nos. 310 and 315, vertical, high-power, drilling machines (the latter size being of the extra-heavy pattern) equipped with a special fixture *a* clamped to the table. This fixture is provided with four tool-steel holding jaws that support the bar in a vertical position, and are operated by right- and left-hand screws by means of a turnstile *b*. At *A*, Fig. 111, is shown the first rough-drilling operation, which is accomplished by means of a 1 13/16-inch diameter high-speed drill driven at 175 R. P. M. with a down feed of 0.020 inch per revolution. The drilling time is about three minutes per shell; *B* shows the second operation, which consists in removing the vee left by the point of the drill, and rounding the bottom; and *C* shows the final reaming operation. In Fig. 112, *D* illustrates the special tool used for machining the exterior of the nose of the shell. This tool is designed along the principles of a hollow-mill carrying one inserted high-speed steel blade. In this setup, a special bushed bracket is fastened to the top of the fixture, to support the large nose turning tool.

Previous to cutting the thread in the nose of the shell, it is necessary to recess it at the point where the thread terminates, as shown at *E*. This is accomplished by a recessing tool of the construction shown in Fig. 113. This tool consists of a holder *A* provided with a tang fitting into the drilling-machine spindle. This carries a sleeve *B* that is

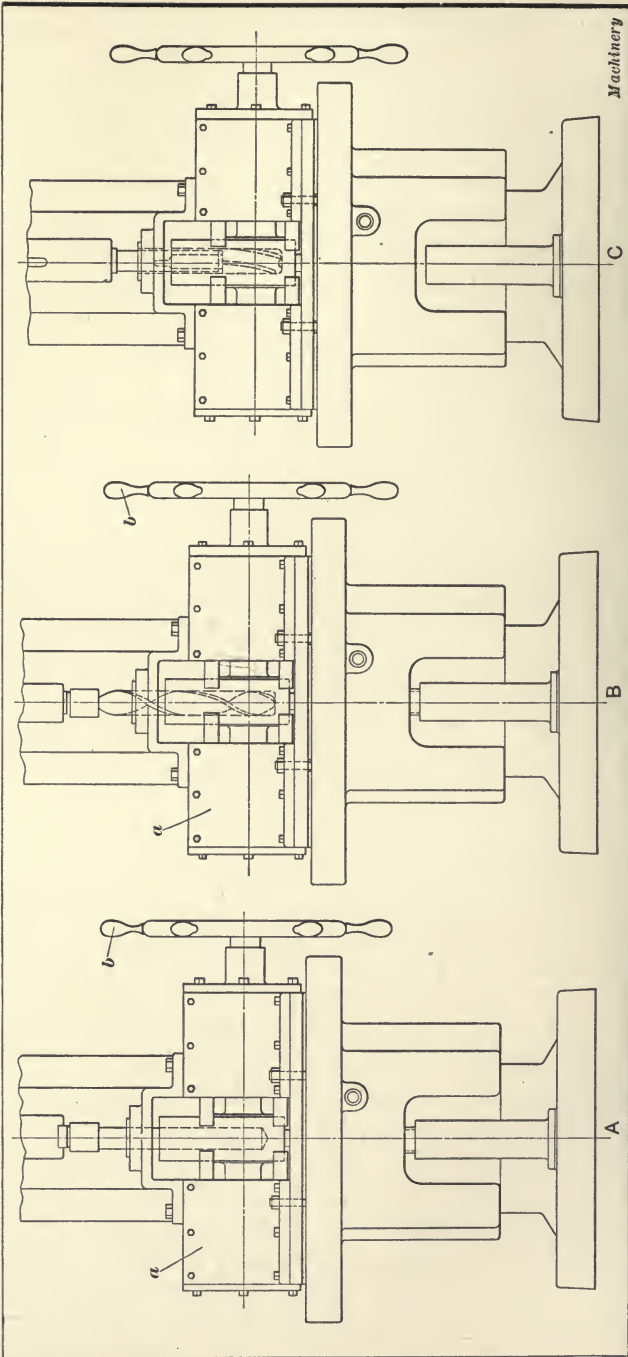

Fig. 111. Preliminary Operations in roughing out a British High-explosive Shell on a High-power Drilling Machine

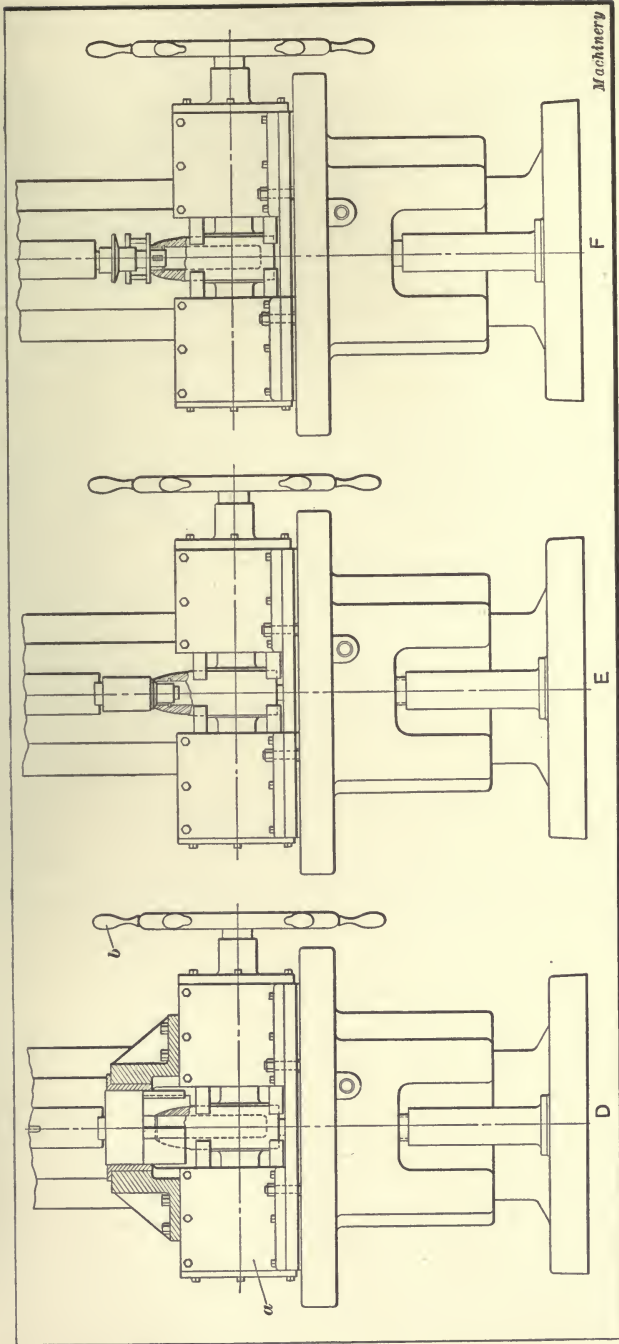

Fig. 112. Turning, recessing and tapping High-explosive Shells on a High-power Drilling Machine

operated upon by a spring *C*, lying between the recessed shoulder of the sleeve and a washer *D* that is pinned to the bar *A*. The recessing tool proper *E* is carried in an elongated slot in the lower end of the bar *A* and is operated by means of an angular slot in the bar through a pin driven through the recessing tool. In operation, the drilling-machine spindle is brought down until the sleeve *B* contacts with the nose of the shell, whereupon, further downward movement of the spindle compresses spring *C* and at the same time forces out the recessing tool *E*, cutting an annular groove in the interior of the nose. The last operation, as performed in the drilling machine, consists in threading, and

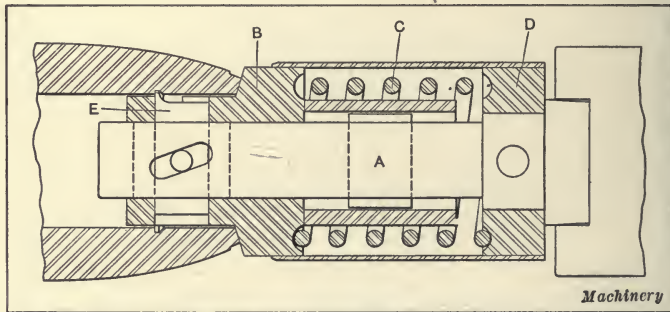

Fig. 113. Special Recessing Tool used for performing Operation E shown in Fig. 112

it is accomplished with a collapsible tap as illustrated at *F*, Fig. 112.

The lay-out advocated by Baker Bros. for this work is a gang of six machines, consisting of two No. 315 extra-heavy pattern machines for the drilling and nose-turning operations, and four No. 310 machines for the bottoming, reaming, counterboring, facing, under-cutting, and tapping operations. This gang of six machines gives a production of eight shells per hour, and leaves them ready for the lathe-turning operations.

Surfacing Gas Plugs on Besly Ring-wheel Grinders.—The gas plug used in the base end of British high-explosive shells is made from a forging and must be faced on the end that is next to the shell. Several methods are used in sur-

facing the inner face of this plug; a very satisfactory one is to grind it on a Besly, No. 14-16, wet, ring-wheel grinder, shown in Fig. 114, which is equipped with a special rotary chuck, shown in detail in Fig. 115. Fig. 114 shows two operators at work grinding the face of gas plugs. The jaws of this rotary chuck are threaded to grip the threaded body of the plug when the latter is machined; consequently, the base is finished true with the threaded body of the plug. For grinding, a cylinder type of wheel is held in the standard, Besly, pressed-steel, ring-wheel chuck. The wheel is



Fig. 114. Surfacing High-explosive Shell Gas Plugs on a Besly No. 14-16-Inch
L "Wet" Ring-wheel Grinder

about 16 inches in diameter, 3 inches face. Gas plugs for British 4.5-inch high-explosive shells can be turned out from the rough at the rate of from sixty to eighty per hour for one operator by this machine. The machine, of course, is double-ended, so that two operators can work on one machine at the same time. The action of the grinding wheel rotates the work while grinding, producing the desired accuracy.

The Besly grinder shown in Fig. 114 is also used for grinding off the projections on gas plugs and facing the

base end. On the British, 18-pound, high-explosive shell, the projection on the end of the gas plug is about $\frac{3}{4}$ inch long and $\frac{7}{8}$ inch in diameter, of square section. (In some cases this section is made triangular in shape.) On the

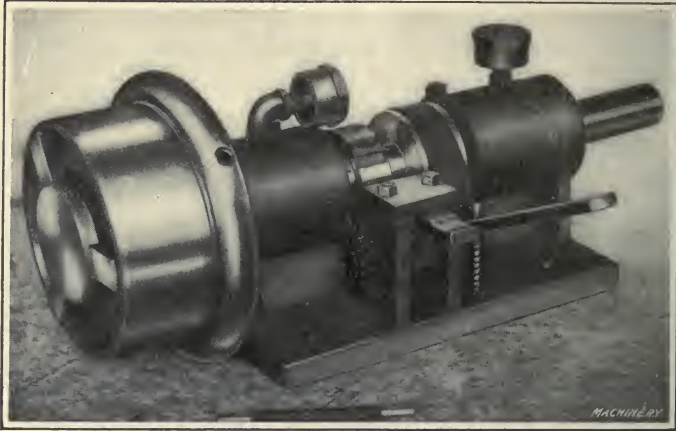

Fig. 115. Special Rotary Chuck used on Besly Disk Grinder for surfacing Gas Plugs

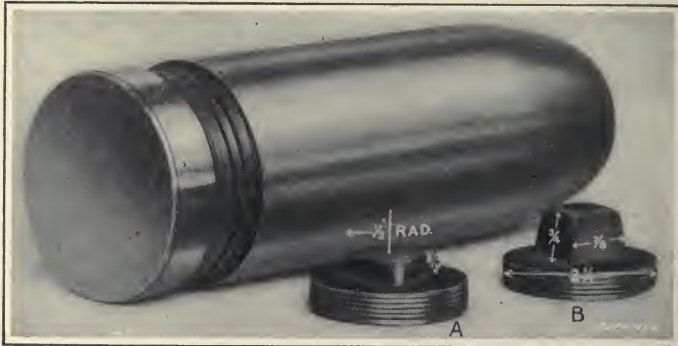

Fig. 116. Three-Inch High-explosive Shell, showing Finish left by Besly Grinder; also Two Types of Gas Plugs

Besly grinder, twenty-five shells can be ground per hour. The grinding machine, of course, accommodates two operators, giving a combined production of fifty shells per hour per machine. At the same time that the projection is removed from the gas plug, the surface of the gas plug is

also ground, $1/32$ inch of material being removed. The diameter of the plug on the 18-pound shell is about $2\frac{1}{4}$ inches, as shown in Fig. 116. Where the projection on the gas plug is triangular in shape, the production can be



Fig. 117. Testing Hardness of High-explosive Shells with Scleroscope

greatly increased because this projection is only $\frac{3}{8}$ instead of $\frac{3}{4}$ inch high. On the type of gas plug here described, the production is about 100 shells per hour per operator, or 200 shells per machine. Fig. 116 shows a British high-explosive shell that has been finished off on the base on the

Besly grinder illustrated in Fig. 114 and also the two types of gas plugs referred to. The one shown at *A* is of triangular section, whereas the one shown at *B* is of square section with a hole in the center.

Testing Hardness of High-explosive Shells.—When orders for high-explosive and shrapnel shells were first placed in the United States and Canada, considerable trouble was experienced in getting shells to pass the government inspectors. While a large number of concerns were successful in getting the shells finished to the required dimensions, many experienced trouble in heat-treating shrapnel shells and attaining the desired physical properties. The government inspectors finally decided on using testing apparatus that could be applied to every shell after heat-treatment and thus check up the tensile strength of the shells. There are two well-known methods of testing the hardness of metals, the Shore and the Brinell. The Brinell is the older and uses the instrument shown in Fig. 81; the Shore makes use of the scleroscope shown in Fig. 117. The British government has been using both of these methods for some time, but, in general, on shell work, the Shore method has been adopted because of the rapidity with which the test could be made. Also it did not injure the parts and could be used on hardened metal, for which the Brinell method is not as adaptable.

Extensive tests have shown that there is very little difference in the results obtained with these methods. What little difference there is, is due principally to the Brinell indenting pressure, which is applied slowly and then left on for fifteen seconds or more. The time taken and the extreme stress imposed causes undue variation depending on the ductility of the metal. In fact, the Brinell reading is so influenced by ductility that claims have been made that it shows the ultimate strength; as a matter of fact, however, the reading taken by the Brinell method is an expression of the elastic limit. The scleroscope, on the other hand, imposes on the metal an instantaneous limited stress, and thus causes only slight mechanical super-hardening, so it logically preserves the original values and serves

to indicate the elastic limit without undue variation leaning toward the ultimate strength. It is for this reason that exact comparison between the two tests can only be made on one kind of metal at a time or in a given state of heat-treatment. On heat-treated steel used in shrapnel and high-explosive shells, the ratio is given by Shore as 6.4, meaning that if the scleroscope shows, for example, 50 hard, this multiplied by 6.4 would give the Brinell hardness, or a value of 320.

Hardness of High-explosive Shells. — The shells used by the British government are made from a special tough alloy steel, the required physical properties of which are contained in the "raw" steel, so that it does not require to be heat-treated after machining. Their specifications are:

Constituents	Per Cent	
	Min.	Max.
Carbon	0.55
Nickel	0.50
Silicon	0.30
Manganese	0.4	1.00
Sulphur	0.04
Phosphorus	0.04
Copper	0.10

This steel in an untreated condition must give a yield point of 19 tons and a breaking strength of from 35 to 49 tons, with an elongation of from 17 to 20 per cent. The scleroscope is used to test each bar of stock after the first external cut or before any of the important machining operations have been performed, so that any defects in the material can be discovered before it has gone too far.

The French high-explosive shell is made from steel containing a lower percentage of carbon and no nickel. The specifications on the French high-explosive shell are:

Constituents	Per Cent	
	Min.	Max.
Carbon	0.30
Silicon	0.18
Manganese	0.50	0.80
Phosphorus	0.04	0.07
Sulphur	0.05

After hardening and tempering, a tensile strength of 125,170 pounds per square inch is required with an 18.3 per cent elongation. The elastic limit would be about from 80,000 to 120,000 pounds per square inch, or as shown in Fig. 117, from 43 to 52 hardness on the scleroscope and from 275 to 333 on the Brinell instrument, respectively. The elongation and ultimate strength are determined by testing a shell, selected at random, to destruction.

The Russian high-explosive shell has a chemical composi-

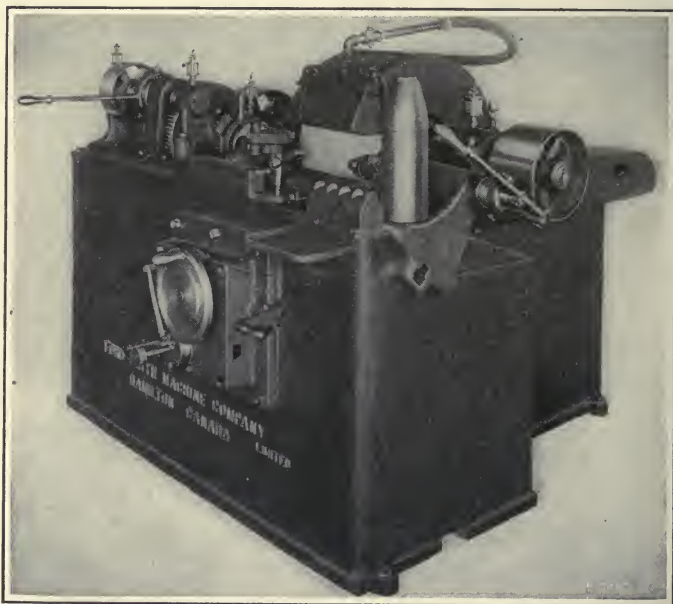

Fig. 118. Ford-Smith Plain Wide Wheel Shell Grinder

tion somewhat similar to the French. It is hardened and tempered to show a physical property giving an elastic limit of not less than 62,000 pounds per square inch, a tensile strength of 118,000 pounds per square inch, and an elongation of 10 per cent. These properties in a steel of the chemical constituents just given would give a scleroscope hardness of from 40 to 45 when heat-treated.

Grinding High-explosive Shells.—The British high-explosive shell is not heat-treated, and, consequently, many

manufacturers are finishing the external diameter to size and shape by turning; others, however, are using the grinding method. The turning method cannot be used as successfully on the Russian or French shells, because these are heat-treated. The practice followed in grinding high-explosive shells differs in various plants. The diagrams, Figs.

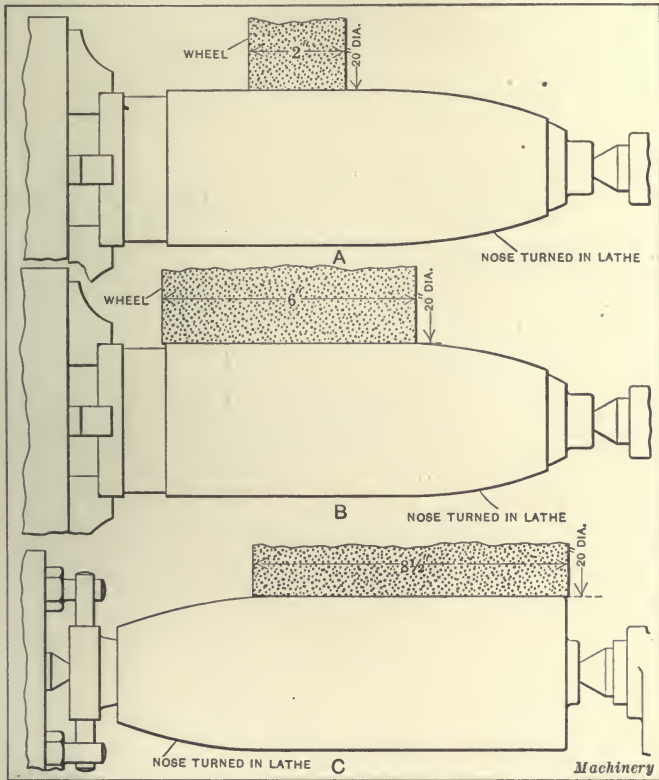

Fig. 119. Diagram Illustrating Methods of finishing High-explosive Shell Bodies by turning and grinding

119 and 120, show several methods that are employed in grinding high-explosive shells on the Ford-Smith heavy-type, plain grinder shown in Fig. 118. Considerable improvements have been made in grinding high-explosive shells, especially as regards keeping the face of the wheel true. When this method was adopted, it was thought that

it would be necessary to true up the face of the wheel with a diamond truing device after grinding a comparatively small number of shells. This, however, has not proved to be the case, and the truing up of the face of the wheel can be done quickly by hand by the use of a carborundum stick. A comparatively large number of shells can be turned out

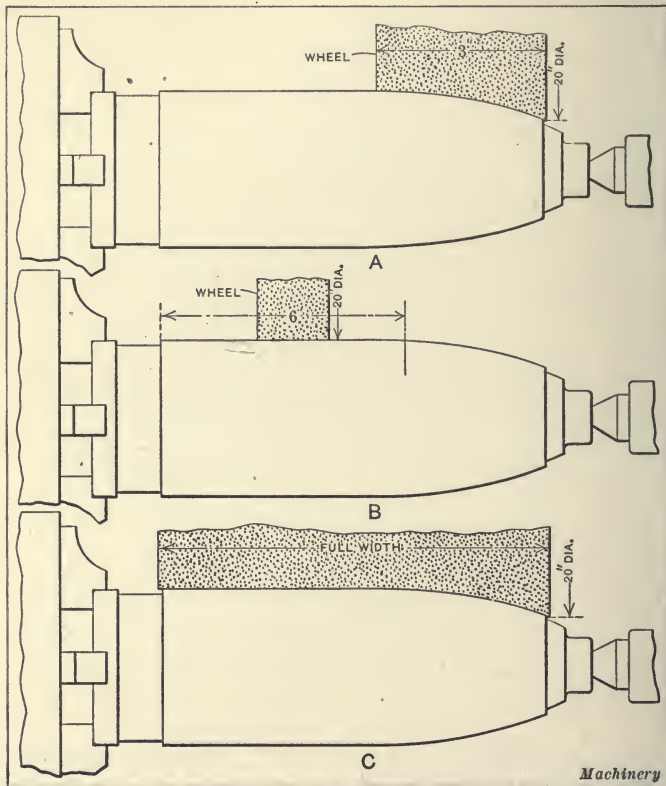

Fig. 120. Diagram illustrating Method of finishing High-explosive Shells by grinding

with one truing of the wheel, and on the Ford-Smith machine a special wheel-truing device, as illustrated in Fig. 121, is used.

The diagram in Fig. 119 illustrates three methods of grinding high-explosive shells of the 18-pound size. That shown at A consists in finishing the nose of the shell on the

lathe, and then grinding the external diameter from the band groove to the radius, with a two-inch face wheel, by traversing the work past the wheel. In the method shown at *B*, a six-inch face wheel is used; this finishes the entire body of the shell, except the nose, which is turned in the lathe in one straight-in cut. The method shown at *C* is that employed on the Ford-Smith grinder in British plants. The nose is turned in the lathe and the body is ground with a wide wheel, generally about 8½ inches. The grinding is done completely across the shell, the band groove being cut in a subsequent operation. The production obtained on



Fig. 121. Wheel-truing Device used on Ford-Smith Grinding Machine

the 18-pound shell when these various methods are used differs considerably. When using the method shown at *A*, the production is about from fifteen to twenty per hour; by method *B*, from twenty to thirty per hour; and by method *C*, from twenty-five to thirty per hour.

Fig. 120 shows methods of finishing high-explosive shell bodies by grinding all over; *A* and *B* show two methods of finishing high-explosive shells on a plain grinder. The procedure followed varies. In some cases, the body is finished first and the nose later, whereas, in others, the nose, as shown at *A*, is ground first and then the body, as shown

at *B*. The method that is shown at *C* is being used in Canada at the present time. In this method, wheels as wide as $11\frac{1}{2}$ inches face have been used, covering the en-

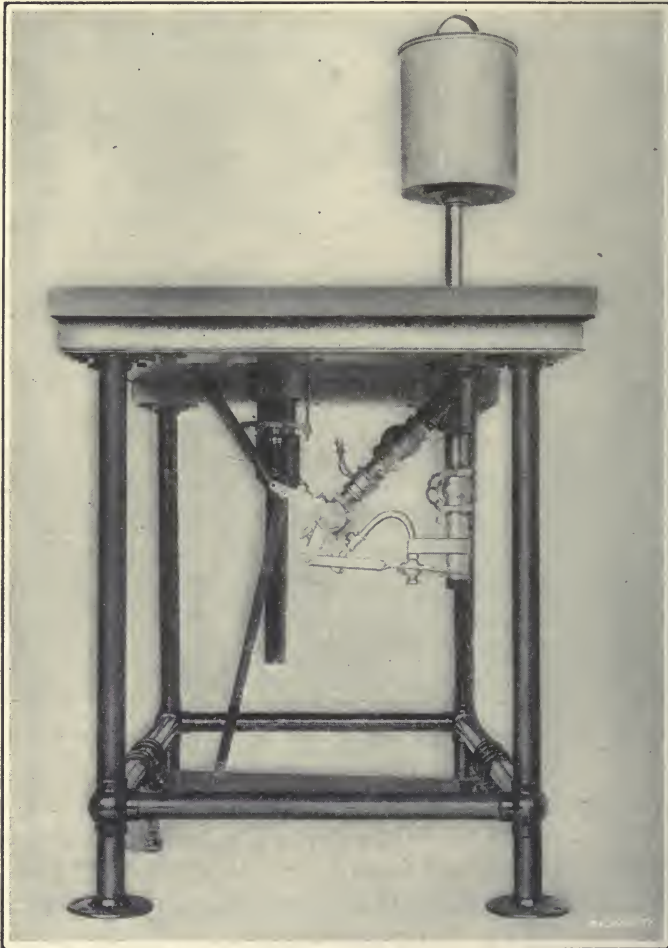

Fig. 122. Machine built by Spray Engineering Co. for spraying Interior of High-explosive Shells

tire length of the shell. On the 18-pound shell, the production varies from twenty to twenty-five per hour, whereas on the 4.5 shell, using an $11\frac{1}{2}$ -inch face wheel, the production is somewhat less.

The special wheel-truing device used on the Ford-Smith plain grinder, shown in Fig. 118, is illustrated in Fig. 121. This device is held on swinging arm bracket *A*, fulcrumed on pin *B*, and located, when in position to true the face of the wheel, by stud *C*. The holder *D*, carrying the diamond tool, is provided at its rear end with a hardened cam surface that is kept in contact with the forming cam *E* by means of a spring located in the body of the attachment. The method of operating this device is as follows: After swinging the attachment into position and locking it, the wheel slide is advanced until the diamond contacts with the wheel; crank handle *F* is then rotated. This carries a gear that meshes with another gear in the enclosed case *G*. The stud in this case extends down through the fixture and engages another gear operating in a rack. Consequently, the turning of this handle moves slide *H* back and forth, and traverses the diamond holder past the face of the wheel. This diamond truing device is only used occasionally to bring the wheel to the correct shape and to dress up new wheels; for slight dressing, a carborundum stick is used.

Varnishing Interior of High-explosive Shells.— In Fig. 122 is shown a machine built by the Spray Engineering Co., Boston, Mass., provided with an apparatus for spraying the necessary protective coating on the inside of a high-explosive shell. The machine comprises a table with steel supporting frames, and has the operating mechanism placed beneath it. The coating material, such as varnish, asphaltum paint, and similar compounds, is carried in a tank located above the operating table, and passes down the hollow tank supports to an adjustable measuring device which controls the amount of material sprayed at each operation. A system of levers controls the motion of this device, cutting off the supply from the tank and admitting measured quantities of material to a channel leading to the spraying nozzle. The last part of this motion opens a connection to a compressed-air supply, which drives the coating material through the spray nozzles and distributes it evenly over the surfaces to be covered. A high working speed is thus obtained without waste of material and one setting of the

measuring device insures delivery of a fixed quantity of the material to each shell.

To operate the machine, the shell is inverted over the hole in the operating table. A slight pressure on the foot lever connected with the operating lever moves the measuring device and admits compressed air. Upon the removal of pressure from the treadle, suitable coil springs return the mechanism to its original position, ready for the next operation. A particular feature of the machine is the device for admitting a fixed amount of coating material at

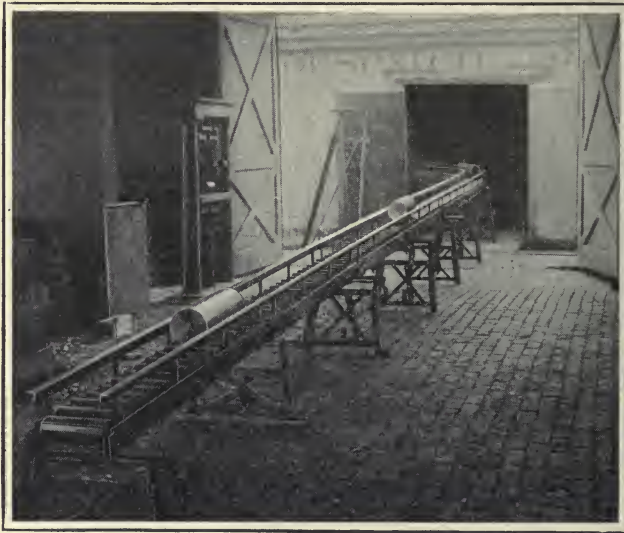

Fig. 123. Mathews Gravity Carrier transporting Shell Forgings

each operation, which permits setting the mechanism to repeat any predetermined coating operation on a large number of similar parts. For readily changing over to different coating materials, drain valves and priming valves permit a thorough cleaning of the measuring device and all pipe passages without taking the mechanism apart. The height of the spray head may be adjusted for coating shells of various dimensions, and auxiliary attachments including a movable spray head are used when it is required to cover a large surface or to meet other special conditions.

Conveying Apparatus for Rapid Handling of Shells.— For conveying shell forgings from one department to another or from the shipping department to freight cars, etc., the Mathews Gravity Carrier Co. has designed conveying apparatus as shown in Figs. 123 and 124, respectively. Fig. 123 shows this gravity carrier being used for transporting forgings from a freight car to the machining department of a plant, whereas Fig. 124 shows a special arrangement of the carrier for handling shells that are boxed and ready for shipment. In this case, the track part, which extends into



Fig. 124. Mathews Gravity Carrier with Elevator Unit loading Freight Car

the shipping room, is about two feet above the floor level and the inclined elevator arrangement lifts the boxes so that they are located in the car four feet above the floor level. The idea of elevating the boxes is to have them within convenient reach of the shipper. The elevator is not necessary where the floor of the car is on the same level as the floor of the building.

The chief advantage of this conveying apparatus is that it is easily and quickly installed and is built up of separate units so that it can be added to without any extra cost except the cost for extra length of carriers and stands. The

rollers are made from seamless cold-drawn steel tubing and run in ball bearings. The grade of the apparatus is from 2 to 3 per cent. Where it is necessary to lift the shells or other parts being transported from a floor into a car, a portable elevator is used as shown in Fig. 124. This elevator is driven by a one-horsepower motor and can be connected to a lamp socket. Another application of this system is where the carrier arrangement comes to the end of the building and it is necessary to return the work; to accomplish this, a double-deck arrangement is provided, the lower deck inclining one way and the upper deck the other way. Thus when the shells or work come to the end of the line, they are simply placed on the upper deck and are returned to the next series of machining operations, without any handling whatsoever. Another advantage of this system is that the shells or work do not need to touch the floor at all, and, consequently, expensive cement floors are not broken up by having heavy work dropped on them. Lifting the work off the carrier is also more convenient than lifting it from the floor.

The important feature of the Mathews gravity roller carriers is that gravity takes the place of other power conveyors, except where additional elevations are necessary or where shells, forgings, and boxes must be elevated to upper floors. For this work, the Mathews Gravity Carrier Co. makes automatic-incline or straight-lift elevators, which require only a very small motor.

CHAPTER IX

BRITISH HIGH-EXPLOSIVE DETONATING FUSE

THE British high-explosive shell described in connection with Fig. 3 carries a nose fuse of the concussion type, also shown in Fig. 9, which is made chiefly from brass parts with the exception of the adapter *B*, Fig. 125, and the gaine, which are made of soft steel. The body of the fuse, shown completely machined at *D*, Fig. 126, and at *C* and *D*, Fig. 127, is first cast in a sand mold in the form of a slug,

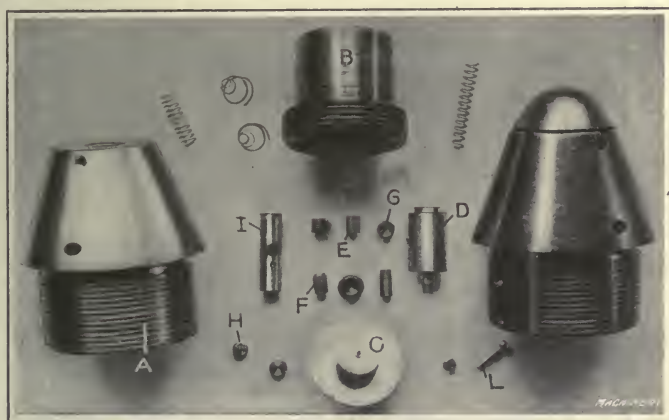

Fig. 125. British No. 100 Graze High-explosive Fuse dismantled and assembled

as shown at *A*, Fig. 126. The composition from which this slug is made is about 59.18 per cent copper, 39.45 per cent zinc, 0.88 per cent manganese copper and 0.49 per cent phosphor-copper, this having been found to give the tensile strength required by the specifications,

The first operation consists in snagging and brushing the castings with a wire brush, but experiments are being made to force the casting through a simple die that shaves off

TABLE V. ORDER OF OPERATIONS ON BRITISH NUMBER 100 GRAZE FUSE

Name of Part	Character of Operation	Material	Machine	Speed, R. P. M.	Production Per Hour
Body	First Machining	Cast Brass	Hand Screw Machine	376	12 to 15
Body	Second Machining	Cast Brass	Hand Screw Machine	570	8
Body	Drill and Counterbore	Cast Brass	Leland-Gifford Three-spindle Drill	6000	65
Body	Drill and Counterbore	Cast Brass	Leland-Gifford Three-spindle Drill	6000	65
Body	Drill	Cast Brass	Leland-Gifford Two-spindle Drill	3000	120
Body	Drill and Counterbore	Cast Brass	Leland-Gifford Three-spindle Drill	4000	60
Body	Mill Wrench Hole	Cast Brass	Leland-Gifford Single-spindle Drill	6000	150
Body	Recess	Cast Brass	Leland-Gifford Single-spindle Drill	4000	375
Body	Countersink	Cast Brass	Leland-Gifford Single-spindle Drill	250	120
Body	Tap Five Holes	Cast Brass	Drilling Machine	150	..
Cap	Form and Cut Off	1 3/8" Brass Rod	No. 55 Acme Auto.	520	150
Cap	Drill	1 3/8" Brass Rod	Leland-Gifford Single-spindle Drill	8000	200
Adapter	Form, Drill, Shave, Counterbore, Thread, Cut Off	1 11/16" Soft Steel Rod	No. 56 Acme Auto.	290	45
Adapter	Counterbore, Drill and Tap	1 11/16" Soft Steel Rod	Model A Cleve. Auto.	60
Graze Pellet	Form, Neck and Drill	9/16" Brass Rod	No. 62 Acme Auto.	980	300

TABLE V. ORDER OF OPERATIONS ON BRITISH NUMBER 100 GRAZE FUSE—(Continued).

Name of Part	Character of Operation	Material	Machine	Speed, R. P. M.	Production Per Hour
Graze Pellet	Drill	9/16" Brass Rod	Leland-Gifford Single-spindle Drill	8000	50
Graze Pellet	Drill, Bottom and Counterbore	9/16" Brass Rod	Leland-Gifford Three-spindle Drill	6000	150
Percussion Pellet	Turn, Chamfer, Drill, Recess, Tap, Cut Off	11/32" Brass Rod	No. 52 Acme Auto.	980	360
Percussion Pellet	Drill and Ream	11/32" Brass Rod	Leland-Gifford Three-spindle Drill	4000 to 8000	..
Percussion Det. Plug	Machine	13/32" Brass Rod	No. 515 Acme Auto.	1230	720
Percussion Det. Plug	Drill	13/32" Brass Rod	Leland-Gifford Single-spindle Drill	8000	200
Percussion Needle Plug	Machine	9/32" Brass Rod	No. 52 Acme Auto.	980	695
Percussion Needle Plug	Drill Four Holes	9/32" Brass Rod	Leland-Gifford Single-spindle Drill	8000	100
Bottom Detent	Form and Center, Drill, Form Hole, Cut Off	7/32" Brass Rod	No. 515 Acme Auto.	1230	720
Top Detent	Rough-finish-turn, Form, Chamfer, Shave, Cut Off	5/32" Phos. Bronze	No. 515 Acme Auto.	1230	210
Top and Bottom Detent	Assemble	5/32" Phos. Bronze	By Hand
Detent Plug	Machine	9/32" Brass Rod	No. 515 Acme Auto.	1230	720
Centrifugal Bolt	Shave and Cut Off	7/32" Brass Rod	No. 515 Acme Auto.	1230	1020
Detent Spring Screw	Brass Rod	No. 515 Acme Auto.	1230	700
Cap Screw	3/16" Steel Rod	No. 515 Acme Auto.	1230	500
Cap Screw	Mill Slot	3/16" Steel Rod	Acme Screw Slotter	2500
Adapter Screw	3/16" Steel Rod	No. 515 Acme Auto.	1230	600
Adapter Screw	Mill Slot	3/16" Steel Rod	Acme Screw Slotter	1500
Detent Plug Screw	9/32" Brass Rod	No. 52 Acme Auto.	980	750
Detent Plug Screw	Mill Slot	9/32" Brass Rod	Acme Screw Slotter	1800

Machinery

the straight surface and removes all objectionable projections. After casting, the slugs are sand-blasted, or otherwise cleaned, and are then placed in the Stewart furnace shown in Fig. 128, where they are heated to 1600 degrees F. (about 870 degrees C.). The ovens of these Stewart gas furnaces are double ended, and a Zeh & Hahnemann percussion press, Fig. 129, is located at one end of the furnace. Three men are required for each forging press; one loads the furnace from the rear, another takes the heated forgings out of the front end of the furnace, puts them in the die, and trips the press, and the third removes them from the dies. After the slugs have reached a temperature of 1600 degrees F., they are removed from the furnace and

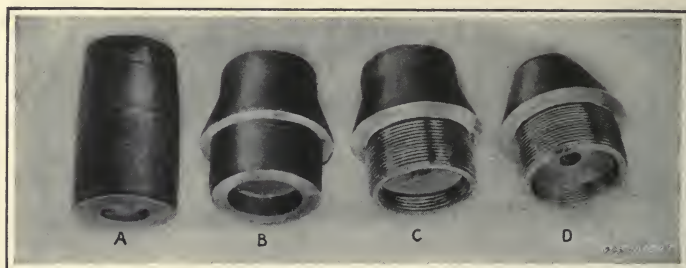

Fig. 126. Sequence of Operations on Body of British No. 100 Graze High-explosive Fuse

placed in the dies shown in Fig. 130, and in Fig. 131 removed from the press. The furnace shown in Fig. 128 holds forty-eight slugs, and from 1400 to 1500 forgings are secured from each press in a day of $9\frac{3}{4}$ hours. The ideal forging obtained from the dies is one in which there is $\frac{3}{64}$ inch of material to remove all around. The dies shown in Figs. 130 and 131 are kept flushed with a compound consisting of 64 per cent oil, 32 per cent water, 3 per cent powdered graphite, and 1 per cent soda ash. The order in which these operations are accomplished, as well as the machines used, spindle speeds, and the production obtained, are given in Table V.

First Machining Operation on Fuse Body.— For the first machining operation, the brass body is held in an air chuck,

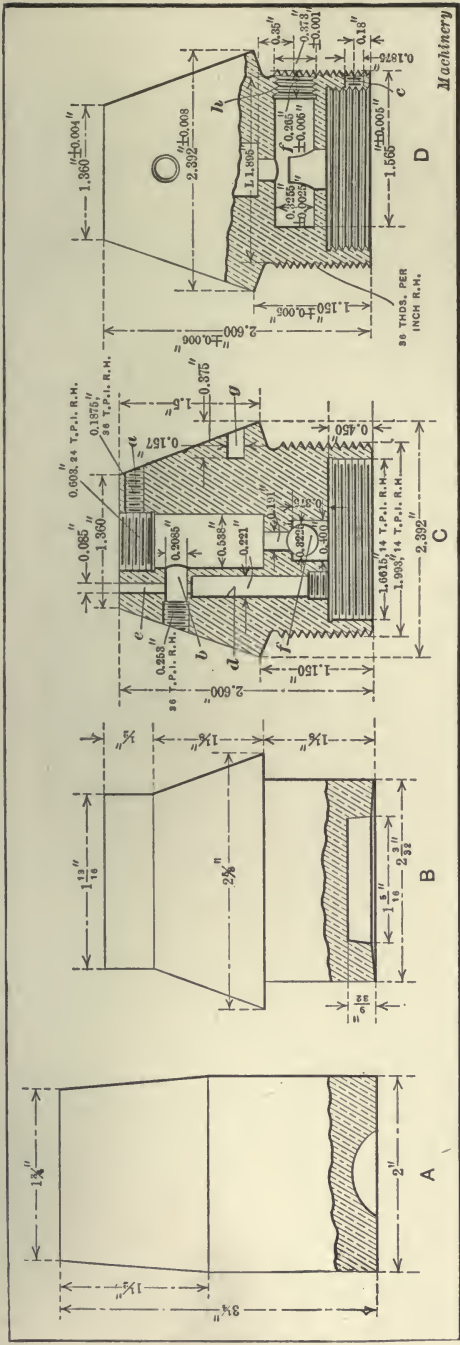

Fig. 127. Various Stages in the Manufacture of the British No. 100 Graze High-explosive Fuse

as shown in Fig. 132, with the end subsequently to be threaded projecting. The first operation consists in turning the body and roughing the angle with the tool *G* in the front of the cross-slide. The next is facing the end, also chamfering and roughing the chamber with tool *A*; then finish-counter-boring and chamfering outside, with tool *B*; under-cutting with tool *C*; taking cut across face, with

tool on rear of cross-slide; tapping, with tool *D*; threading, with Geometric collapsing die *E*; and drilling and reaming the center hole, with tool *F*. After threading in the machine, a hand-threading operation is necessary to size the thread on the body. The lubricant used on this job consists of 1.06 per cent soda ash, 15.67 per cent mineral lard oil, and 83.27 per cent water.

Second Machining Operation on Fuse Body.— The second machining operation on the fuse body consists in finishing the taper end. The threaded end, as shown in Fig. 133, is gripped in an air chuck and the following operations performed: Face with cross-slide tool *G*, center with tool *A*, drill and rough-turn with tool *B*, rough-counterbore with tool *C*, recess with tool *D*, drill with tool *E*, tap with tool *F*, and shave angle on body with shaving tool *H* held on rear of cross-slide.

Drilling Operations on Fuse Body. — Following the machining operations just described, the fuse body passes

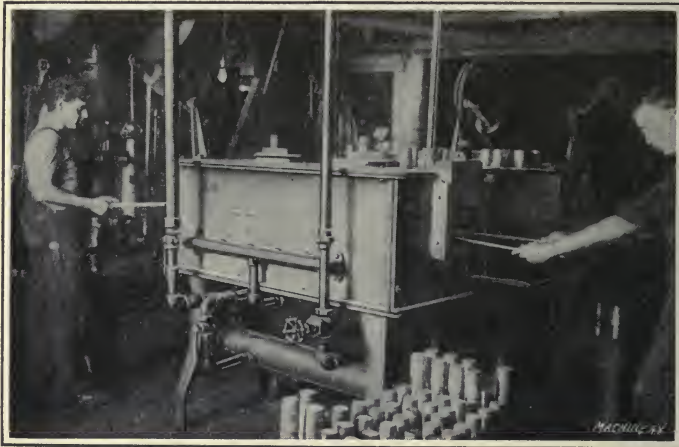

Fig. 128. Stewart Gas Furnace used for heating Castings previous to hot-pressing

through drilling, counterboring, and tapping operations, which are performed on Leland-Gifford drilling machines. Fig. 127 gives the sequence of these operations.

The first drilling operation on the machined body consists in drilling the cap set-screw hole *a*, drilling and counterboring the centrifugal bolt hole *b*, and drilling the adapter set-screw hole *c*. For this operation, a three-spindle drilling machine is employed. The four operations are performed on the three-spindle machine because the cap set-screw hole *a* and the adapter set-screw hole *c* are the same diameter, and, therefore, machined by the same drill.

The second set of drilling operations is drilling the de-
tent spring hole *d* with a drill in one spindle of a three-
spindle drilling machine. The second spindle carries a

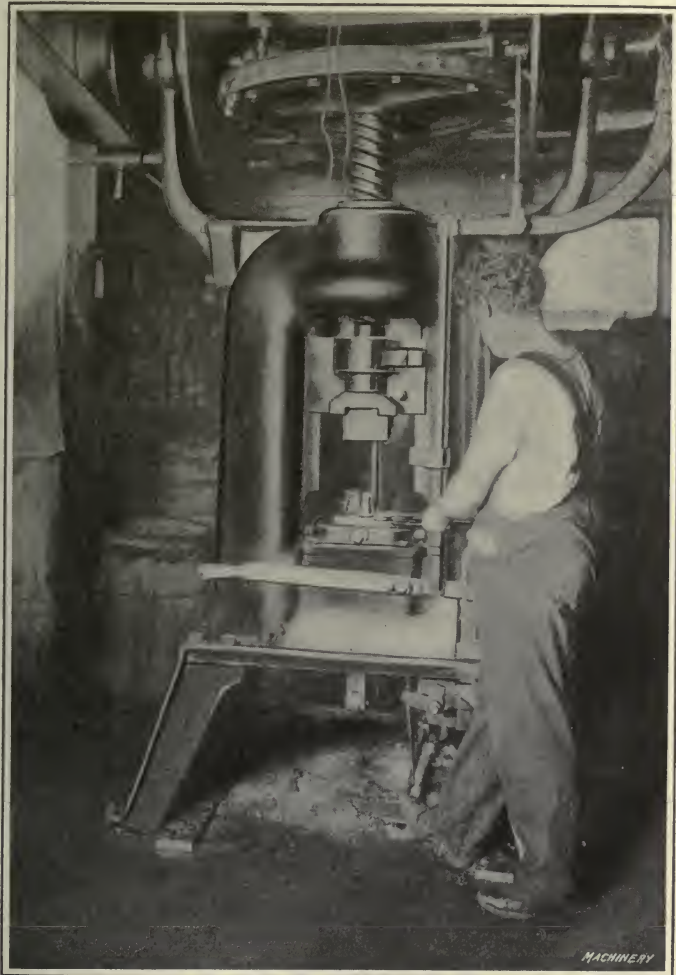

Fig. 129. Zeh & Hahnemann Percussion Press used in hot-
pressing Fuse Bodies

counterboring tool that squares the bottom of the hole, and
the third spindle carries a counterboring tool.

The third set of drilling operations is the drilling of the

hole for the reception of the detent. This is performed on a two-spindle drill press, each spindle carrying the same size drill, except that one is much longer than the other. The longer of the two drills is used with a special fixture for

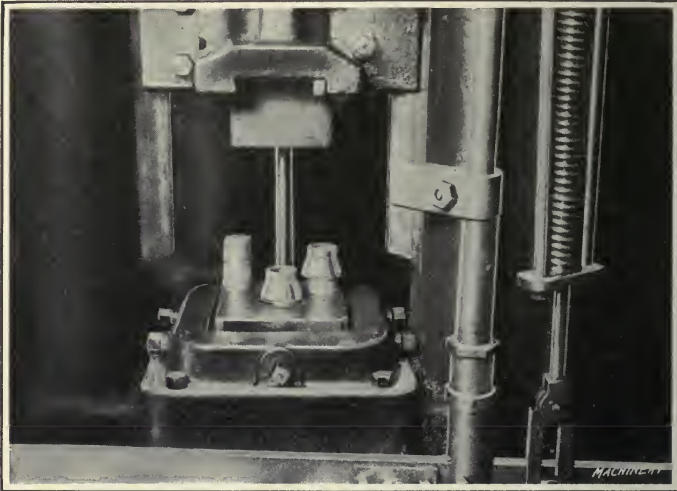

Fig. 130. Close View of Percussion Press shown in Fig. 129 showing Dies used and Casting before and after forging



Fig. 131. Upper and Lower Dies used in Press shown in Fig. 129.

drilling two-thirds of the detent hole e from the bottom side. The hole is completed by drilling from the top, using a second fixture and the short drill in the second spindle of the machine.

The fourth set of drilling operations is performed on a three-spindle drilling machine. The first spindle carries a

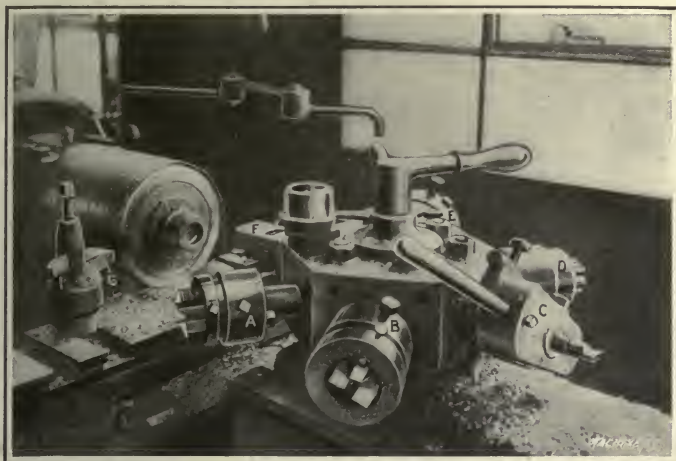

Fig. 132. Set-up on Warner & Swasey Brass-working Lathe for performing First Series of Machining Operations on Fuse Body

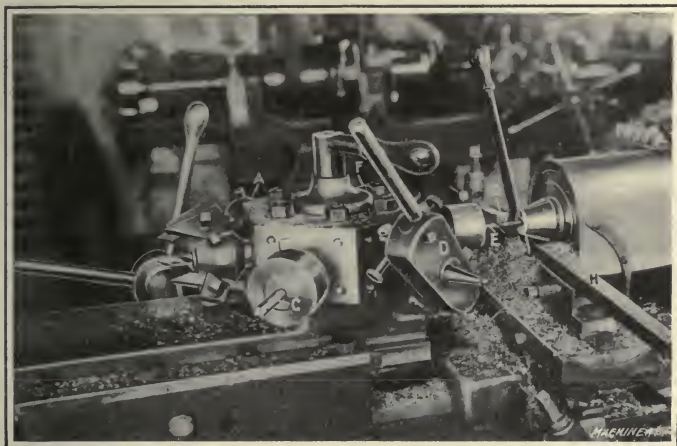

Fig. 133. Set-up on Warner & Swasey Brass-working Lathe for performing Second Series of Operations on Fuse Body

drill for drilling the central percussion pellet hole *f*, Fig. 127; the second spindle carries a counterboring tool; the third spindle carries a bottoming tool.

The seventh operation on the fuse body is the milling of the oval wrench hole *g*. This is done in a single-spindle drilling machine, the work being held in a special fixture so that it may be moved backward and forward slightly to produce the oval hole required. The eighth operation

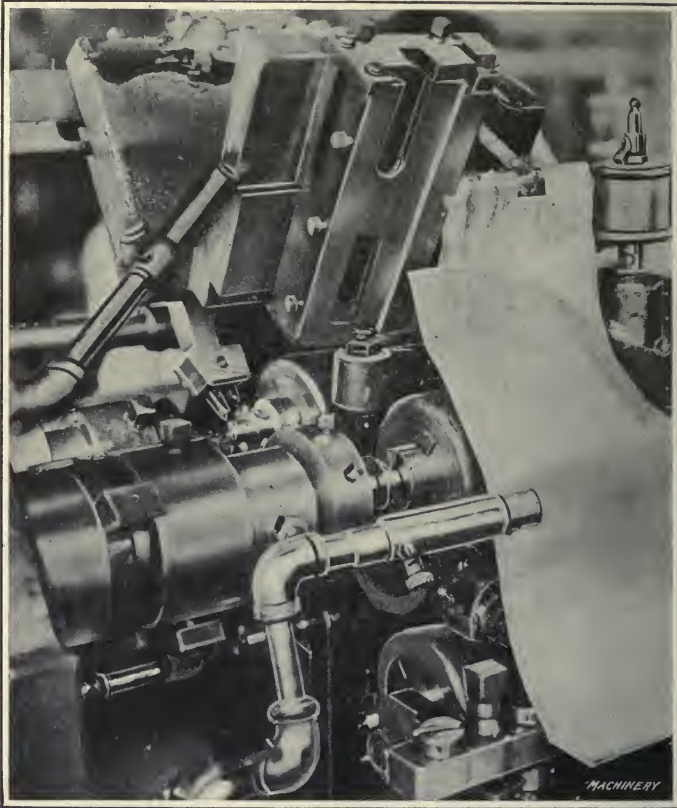

Fig. 134. Set-up on No. 55 Acme Multiple-spindle Automatic Screw Machine for machining Fuse Cap

is the recessing of the percussion pellet hole *h* for the thread. A single-spindle drilling machine, equipped with a special fixture to provide for under-cutting, is used. The ninth set of operations consists in slightly countersinking or burring all of the holes. This is done with a large countersink in a single-spindle drilling machine, the fuse bodies being held

by hand against the countersink. The tenth and last set of operations consists in tapping five holes, namely, the set-screw holes for the cap and adapter, the detent spring hole, the centrifugal bolt hole and the percussion pellet hole. Four separate machines are used for tapping, each of which carries a tapping head.

Machining the Fuse Cap. — The fuse cap *C*, Fig. 125, is made from brass rod $1\frac{3}{8}$ inch in diameter in an Acme No.55 multiple-spindle screw machine, as shown in Fig. 134. The order of operations is: Form and center, drill, bottom, and

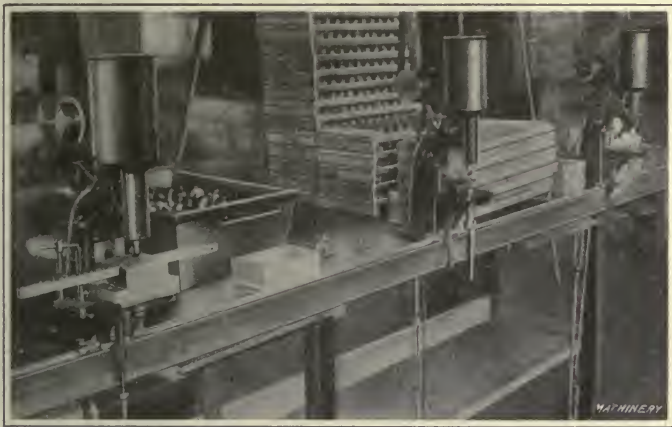

Fig. 135. Grant Riveting Machines used in riveting Needle In Percussion Needle Plug

neck, thread with button die, and cut off. The production on this particular piece is given in Table V; after coming from the screw machine it is put through a chip separator where the oil and chips are separated. The next operation is drilling the two wrench holes, which is handled on a single-spindle drilling machine, the jig being shifted on the table to drill the two holes.

Operations on Graze Pellet. — The graze pellet *D*, Fig. 125, is made from 9/16-inch brass rod in a No. 52 National-Acme multiple-spindle automatic screw machine. The operations are as follows: Turn full diameter and also 0.370 diameter with a double tool, also drill and start neck, recess

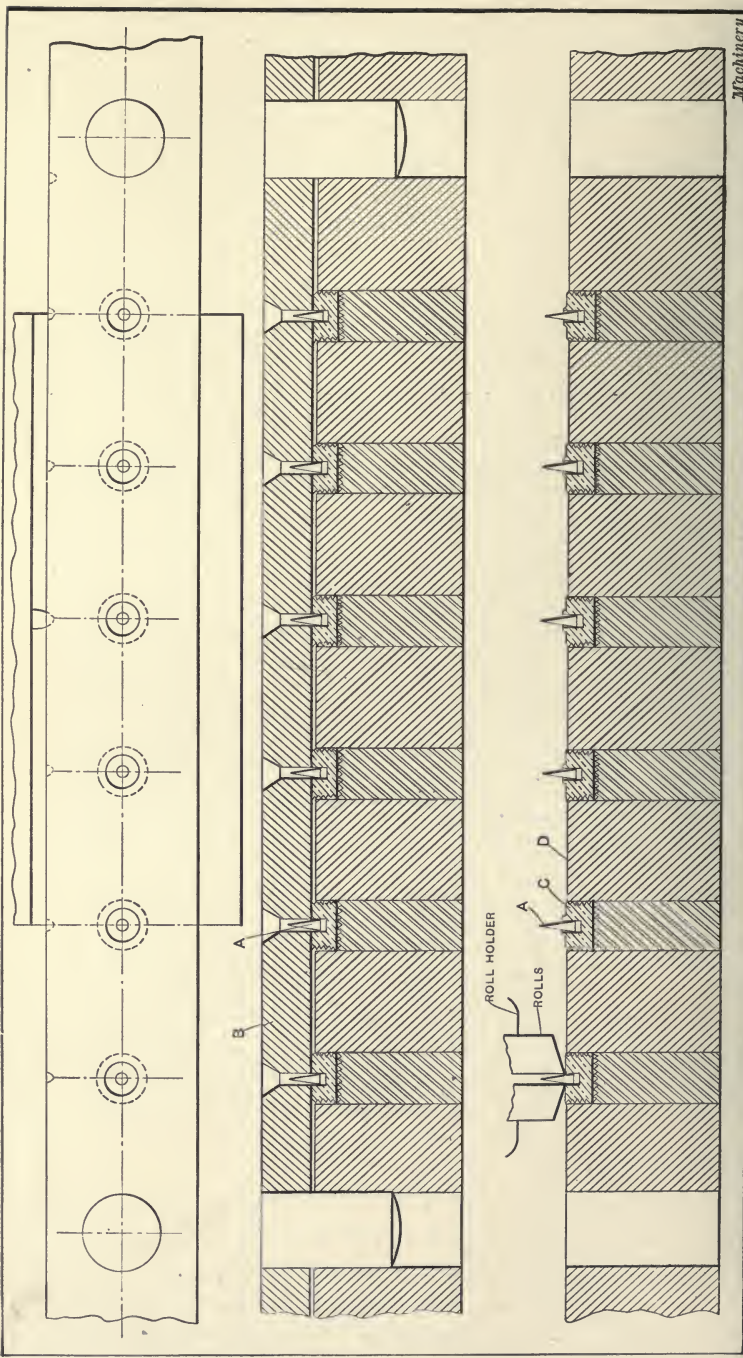

Fig. 136. Diagram showing Construction of Fixture used in assembling Percussion Needle Plug

and continue neck, tap and finish neck, cut off. The piece is finished on leaving the screw machine. The production is given in Table V, which also includes a complete summary of the operations performed on the various parts of this fuse.

There are two drilling operations on the graze pellet. The first consists in drilling the small fire hole through the entire length of the piece. This is done in a single-spindle drilling machine and is followed by the operations on the upper end of the piece, where the detonating cap is held. The operations on this end are performed in a three-spindle drilling machine; the first spindle carries the drill for producing the large hole, the second carries a counter-boring tool and the third a facing tool for the bottom of the hole.

Operations on Centrifugal Bolt and Plugs. — The centrifugal bolt *E*, Fig. 125, is made from brass rod, the operations consisting merely in shaving and cutting off. The percussion detent plug *G* and the percussion needle plug *H* are also simple screw machine jobs. The needles are made of steel and are swaged down to a fine point and then hardened. The spinning in place of the needle point is done on the Grant rivet spinning machines shown in Fig. 135, on which a simple fixture shown by the diagram Fig. 136 is employed. Two girls are employed on this work; one inserts the needles *A* in plate *B*, and the plugs *C* in plate *D*, and the other operates the machine. The holes in the top plate are large enough to allow the needles to drop through freely and enter the plugs; then the top plate is removed and the fixture placed on the table of the spinning machine. The spinning rolls are brought down in contact with the plugs consecutively and spin in the edge, holding the needles firmly in place. The plugs are prevented from rotating by steel inserts that are knurled on their top faces. Location of the various holes under the spinning machine is accomplished as shown in the plan view, Fig. 136.

The operations on the percussion detonator plug are performed on a single-spindle drilling machine, and consist in drilling the two small holes with the aid of a swivel jig.

The four small fire holes in the percussion needle plug are drilled after the needle has been swaged in place. The drilling operation is left until last, as otherwise the swaging operation would close up the fire holes.

Machining Operations on Percussion Pellet. — The percussion pellet *I*, Fig. 125, is made from 11/32-inch diameter brass rods in a multiple-spindle automatic screw machine. The operation consists in turning with a box-tool, chamfering and squaring the threaded end, also drilling the hole and squaring the bottom, recessing, tapping, and drilling the small hole and cutting off. The hole in the opposite



Fig. 137. Baking Varnish on High-explosive Shell Fuses

end of the percussion pellet and the one in the side are drilled in a three-spindle drilling machine. The same size drill is used for drilling the large cross-hole and the end hole. This drill is held in the first spindle, and a smaller drill, held in the second spindle, drills the small cross-hole, whereas the third spindle carries a taper reamer for tapering the large cross-hole.

Operations on Top and Bottom Detents. — The bottom and top detents *F* and *L*, respectively, Fig. 125, are made with a simple tool equipment. The top detent *L* is made

from 5/32-inch bronze rod in a screw machine, whereas the bottom detent *F* is made from brass rod 7/32-inch in diameter in a screw machine. The operations on the top detent are: Rough-turn and form head, finish-turn and chamfer, shave from head to point, and cut off. The operations on the bottom detent are: Form and center, drill, form hole, and cut off.

Operations on Adapter. — The adapter shown at *B*, Fig. 125, is produced in three operations, the first being per-

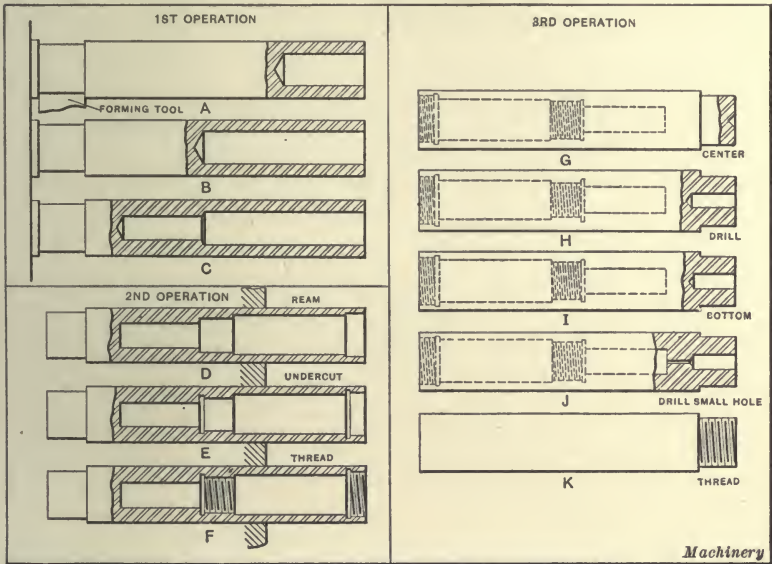

Fig. 138. Diagram Illustrating Sequence of Operations on Galne

formed on an Acme No. 55 multiple-spindle automatic screw machine. The first series of operations is as follows: Rough-form and drill, shave and counterbore, thread outside diameter, and cut off. The second series of operations, performed on a Cleveland automatic screw machine provided with a magazine attachment is: Counterbore, tap, and drill. The third operation, performed in a Leland-Gifford drilling machine, consists in drilling the two small holes. The other small parts, such as screws, etc., are regular screw machine jobs and are simple to manufacture.

Assembling. — The assembling is done in the following order: The percussion pellet, spring, and detonator plug are inserted in the cross-hole; the graze pellet is dropped into place; the centrifugal bolt and screw are inserted from the side; the combined detent, spring, and screw plug are inserted from the base; the creeper spring is put in from the top and the cap screwed in place. The set-screw for the cap and the adapter are then inserted and the gaine is screwed in. The lacquering of the completed fuse is done by spraying, and the lacquered fuses are baked in a rotating oven, shown in Fig. 137, until the varnish is dry.

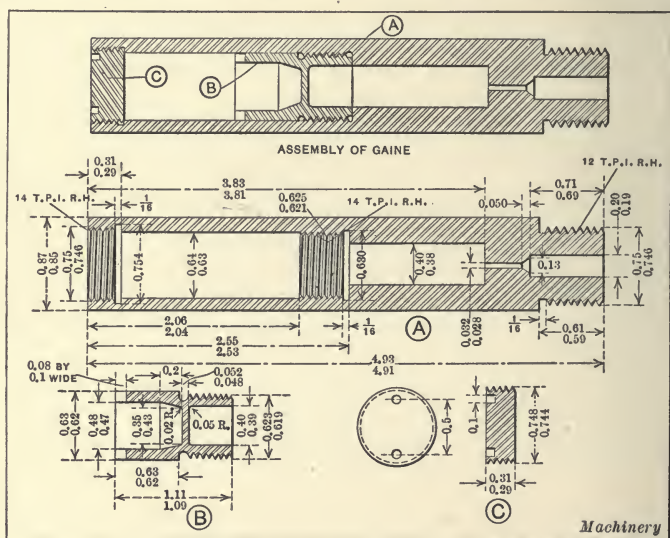

Fig. 139. Assembly and Details of Gaine used in British No. 100 Graze High-explosive Shell Fuse

This oven has six shelves that work on the principle of a Ferris wheel.

Machining British High-explosive Fuse Gaine Parts. — The gaine that forms the exploder member of the British No. 100 graze fuse shown in Fig. 9 is shown assembled and in detail in Fig. 139. As shown, the gaine comprises three parts, *viz.*, body A, center plug B, and closing or bottom plug C. The body A of the gaine is made from cold-rolled steel, and in one plant the first operation is handled in a

No. 53 Acme multiple-spindle automatic in the order shown in Fig. 138. The order of machining operations performed at the first chucking is shown from *A* to *C* inclusive, and is as follows: First position, drill large hole one-third depth, using floating drill-holder, and form the thread diameter from cross-slide; second, drill large hole to shoulder; third, drill small hole; fourth, cut off. In the drilling, a stepped lead cam is used so that the drills can be backed out to clean out the chips and assist the lubricant in getting to the cutting points of the drills. The outer surface of the gaine is not finished and the holes are not reamed. The cutting speed is 100 surface feet per minute, and the production is sixty per hour.

The second series of operations, shown in Fig. 138, is performed on a No. 2 plain-head Warner & Swasey turret lathe, as follows: First, ream the four diameters of the hole with a stepped reamer; second, under-cut at the bottom of the two threaded sections, this is done with a tool having two cutting points properly spaced; third, tap the two holes with a double-threaded tap. The production is thirty pieces per hour and the cutting speed, except for the tapping, is 100 surface feet per minute.

The third series of operations, shown to the right in Fig. 138, is performed on a No. 2 plain-head Warner & Swasey turret lathe, and the piece is held with the threaded end outward. The operations are: First, center; second, drill large hole; third, form bottom of hole; fourth, drill small hole with a high-speed drilling attachment; fifth, thread external diameter with a self-opening die. The cutting speeds on this operation are 100 surface feet per minute and the production is thirty pieces per hour. In the plant where this information was obtained, considerable trouble was experienced in drilling the small hole. Attempts were made to produce this hole in a high-speed drilling machine, with poor results. The method shown at *J* is recommended as being more satisfactory, as in this case both work and drill revolve.

Machining the Center Plug. — The center plug *B*, Fig. 139, is made from hot-rolled machine steel and is completed

in two operations. The first series of operations is performed on a No. 53 Acme multiple-spindle automatic. The operations are: Form the entire length of the piece and drill small hole, shave outside diameter and square bottom of hole, thread, and cut off. The second series of operations is performed on a No. 2 plain-head Warner & Swasey turret lathe in the following order: Center drill, drill, form hole with special counterboring tool, and face end with tool on rear cross-slide. These pieces are handled at the rate of forty-five per hour. The work on this piece is completed by a simple slotting operation on an Acme screw slotter. The machining of the bottom plug *C* is performed on a No. 53 Acme multiple-spindle automatic. This part is made of cold-rolled steel and turned at a speed of 100 surface feet per minute. The order of operations is: Form external diameter, face end, thread, and cut off. This piece is produced at the rate of 180 per hour. The drilling of the two holes in the end of this plug is performed in a drilling machine with the aid of a simple jig.

CHAPTER X

HIGH-EXPLOSIVE CARTRIDGE CASE MANUFACTURE

THE cartridge case used in the British, 18-pound, quick-firing, field gun is made from an alloy of copper and zinc, generally 70 per cent electrolytic copper and 30 per cent zinc. The exact composition of the alloy is left to the discretion of the manufacturer, but the completed cartridge case must have the required strength and elasticity. The number of redrawing and annealing operations on the case is never less than six, while two tapering operations must also be performed to bring the mouth of the shell to the correct diameter and the body to the right shape. The practice followed in plants making this case does not differ materially in regard to the number of drawing operations, but there is some difference in the methods used in handling the work. The following description covers the method used by a large concern that turns out 4000 18-pound cartridge cases per day of ten hours.

Blanking and Cupping. — The first operation on the cartridge case is to cut out a blank 6.22 inches in diameter from a sheet 0.380 inch thick. This operation is seldom handled by the firm making the cartridge cases, most firms preferring to buy the blanks from manufacturers that make a specialty of this business. The blank is usually cut out in a geared punch press at the rate of about 400 blanks per hour. Usually the blank is in the annealed condition when received by the cartridge case manufacturer. Assuming that the blank is purchased in the annealed condition, the first operation is cupping. In the plant where the following data was obtained, this operation is performed in a Toledo press, as shown in Fig. 140. One operator can turn out 4000 cups in ten hours. On this operation, a production as high as 600 per hour can be obtained, but this pace cannot be kept

TABLE VI. ORDER OF OPERATIONS ON BRITISH 18-POUND CARTRIDGE CASE

Number of Operation	Character of Operation	A, Inches	B, Inches	Machine Used	Lubricant	Furnace Used	Temperature of Furnace Degrees F.	Bath	Production Per Hour
1	Blanking	6.22	0.380						400
2	Cupping	4½	2g	Toledo No. 57 Press					400
3	Anneal for 1 Hour	4½	3½	Toledo No. 59 Press	"New Era"	Special	1250	Water Cooled*	420
4	First Redrawing	4¾	3½	Toledo No. 59 Press	"New Era"	Special	1250	Water Cooled*	400
5	Anneal for 1 Hour	4¾	3½					Water Cooled*	472

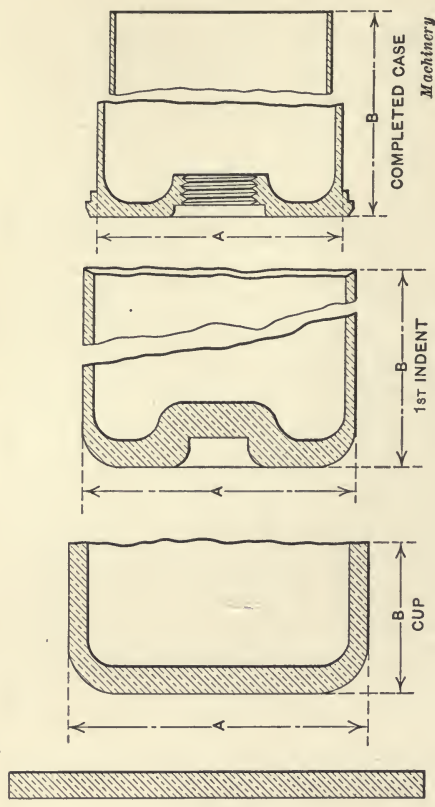

TABLE VI. ORDER OF OPERATIONS ON BRITISH 18-POUND CARTRIDGE CASE—(Continued).

Number of Operation	Character of Operation	A ₁ Inches	B ₁ Inches	Machine Used	Lubricant	Furnace Used	Temperature of Furnace Degrees F.	Bath	Production Per Hour
6	Second Redrawing	4 $\frac{3}{8}$	4 $\frac{11}{16}$	Toledo No. 58 Press	"New Era"	400
7	First Indenting	4 $\frac{3}{8}$	4 $\frac{11}{16}$	Toledo No. 59 $\frac{1}{4}$ Press	300
8	Anneal for 1 Hour 4 Minutes	Special	1250	Water Cooled*	510
9	Third Redrawing	3 $\frac{3}{8}$	5 $\frac{1}{8}$	Toledo No. 57 Press	"New Era"	200
10	Anneal for 1 Hour 4 Minutes	Special	1250	Water Cooled*	540
11	Fourth Redraw	3 $\frac{3}{8}$	8 $\frac{1}{8}$	Toledo No. 857 Press	"New Era"	150
12	Second Indenting	3 $\frac{3}{8}$	8 $\frac{1}{8}$	Toledo No. 59 $\frac{1}{4}$ S Press	250
13	Anneal for 1 Hour 4 Minutes	Special	1250	Water Cooled*	585
14	Fifth Redrawing	3 $\frac{3}{8}$	10 $\frac{1}{8}$	Toledo No. 857 Press	"New Era"	150
15	First Trimming	3 $\frac{3}{8}$	10 $\frac{1}{8}$	Toledo Trimmer	350
16	Anneal for 1 Hour 4 Minutes	Special	1250	Water Cooled*	660
17	Sixth Redrawing	3 $\frac{3}{8}$	14 $\frac{1}{8}$	Toledo No. 856 Press	"New Era"	120
18	Second Trimming	3 $\frac{3}{8}$	11 $\frac{1}{16}$	Toledo Trimmer	350
19	Heading	3 $\frac{3}{8}$	11 $\frac{1}{8}$	Toledo No. 666 Press	150
20	Mouth Anneal 1 Minute	Special	800	Cool in Air	720
21	First Tapering	3 $\frac{3}{8}$	11 $\frac{1}{8}$	Toledo No. 114 Press	"New Era"	250
22	Second Tapering	3.34	11 $\frac{1}{8}$	Toledo No. 114 Press	"New Era"	250
23	Machine Head and Mouth	4.065 head	11.58	Bullard, Trimming, Chamfering and Facing Machine	35
24	Inspect (ten operations)	Standard and Special Gages	400

Machinery

* After cooling in water, cases are dipped in weak sulphuric acid solution and rinsed in warm water.

up by one man. The shape and size of the cup after the cupping operation is shown at *B*, Fig. 143. Table VI gives the complete order of operations.

Annealing.—Following the cupping operation, the metal is hardened somewhat and, consequently, annealing is necessary to restore the required ductility. The hardness of the metal is also tested by means of the scleroscope after each press and annealing operation, and in this plant one per cent of the daily production is given this test. The anneal-



Fig. 140. First Operation—Cupping In a Toledo Press

ing is done in a special furnace, shown in Fig. 141, which is about 6 feet wide by 24 feet long. The cases are loaded into trays and fed into the furnace at the loading end by a ram operated by compressed air. These trays hold, on an average, fifty-six cups, the number depending on the diameter of the case, and each furnace holds eight trays. The furnaces are kept at a constant temperature of 1250 degrees F. (about 680 degrees C.), and the cups are annealed for one hour and four minutes at this temperature. This is the average length of time that each tray is allowed

to remain in the furnace, but the loading and unloading is carried on every eight minutes. As soon as the cups are removed from the furnace they are immersed in water. There are six pyrometers in each furnace for controlling the temperature, three on each side; these pyrometers are tested every fifteen minutes, as shown in Fig. 142, so that any variation in the temperature of the furnaces can be immediately checked up. After cooling in water, the cups are placed in a pickling bath, which consists of twenty parts water to one part sulphuric acid. When removed from this,



Fig. 141. Annealing Cartridge Cases

they are immersed in a high caustic soda bath, and are then washed in warm water to remove all traces of the acid.

All firms engaged in this work, however, do not follow this procedure in cooling and washing. One concern believes that the rapid cooling of the cases in water affects their physical properties, and, hence, allows the cases to cool off in the air after each annealing operation. When cool, the cases are immersed in a bath containing a weak solution of sulphuric acid and then in a weak bath of cyanide of potassium, after which they are rinsed in water.

First and Second Redrawing and Indenting Operations. — Following the cleaning of the cups, they are taken to another Toledo press, shown in Fig. 145, where the first redrawing operation is accomplished. For this, one machine and two men are required for a production of 400 per hour. It will be noticed in Fig. 143, at *C*, that the thickness of the bottom of the case remains the same, the sides alone being reduced in thickness and increased in length; it is important that this thickness at the base is retained. After this, the



Fig. 142. Recording Instruments used In checking up Temperature of Annealing Furnaces

cases are annealed, washed, etc., as before. The only difference here is that the pan holds sixty-three instead of fifty-six cases, due to the smaller diameter of the cases.

The second redrawing operation *D*, Fig. 143, is accomplished in the same manner as the first, and the production is also the same, 400 per hour, two operators being required. Following the second redrawing operation, the cups are taken directly to the first indenting operation, the result of which is shown at *E*, Fig. 143. This operation is accomplished in the Toledo press shown in Fig. 146. It will

be noticed that for indenting the case is placed on the lower punch *A*. Upon the descent of punch *B*, the lower punch is forced down into the die, exposing the indenting punch that is located inside of it. The case also goes down into the die and consequently is prevented from being distorted. Upon the up-stroke, the case is ejected from the die by the

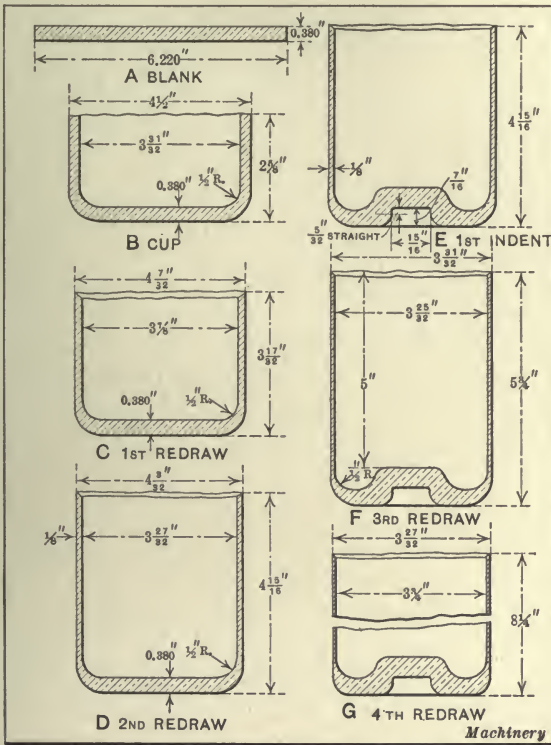

Fig. 143. Sequence of Operations on British 18-pound High-explosive Shell Cartridge Case

double action of the press, and to provide against any chances of its sticking on the punch *B*, an ejector *C* is provided. In this operation, only one operator is required and the production is 300 per hour. The important point to observe in this case is the depth of the indent *E*, Fig. 143, which must be 7/16 inch. Following indenting, the cases are again annealed, each pan holding sixty-eight cases.

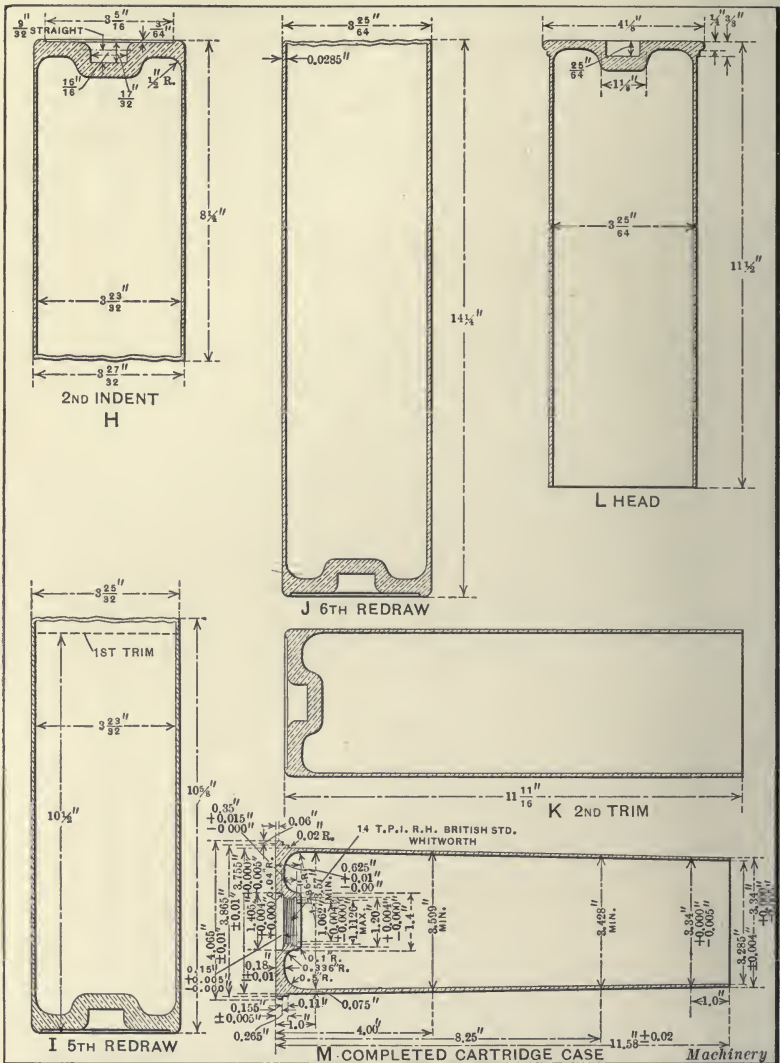

Fig. 144. Sequence of Operations on British 18-pound High-explosive Shell Cartridge Case—Continued (Thickness of Walls Slightly Exaggerated)

Third and Fourth Redrawing and Second Indenting Operations.—The third redrawing operation is accomplished in a No. 57 Toledo press, as shown in Fig. 147. The pro-

duction on this operation is 200 cases per hour and the case is drawn out to the length shown at *F*, Fig. 143, and also reduced slightly in diameter. Two operators are required for this operation. After redrawing, the case is annealed, washed, etc., as before. The annealing pans accommodate seventy-two cases each.



Fig. 145. First Redrawing Operation performed on a Toledo No. 59 Press

The fourth redrawing operation is accomplished in a No. 857 Toledo press; the production is 150 cases per hour, and two operators are required. The result of this operation is shown at *G*, Fig. 143. Following the fourth redrawing operation, the cartridge case is given the second indent, as shown in Fig. 148. Reference to *H*, Fig. 144, will show that the head of the case is somewhat flattened in this operation,

leaving a projection raised around the outer rim. The depth from the flat surface of the head to the bottom of the indent is the most important dimension; this depth on the 18-pound cartridge case must be $17/32$ inch. The production at this operation, two operators being employed, is 250 cases per hour. Following the second indent, the cases are again annealed, washed, etc. The pans, in this case, carry



Fig. 146. First Indent on a Toledo Press

seventy-eight cases because of the reduced diameter. The presses used in performing the cupping, redrawing, reducing, and heading operations vary in ram capacity from 500 to 1200 tons pressure per square inch.

Fifth and Sixth Redrawing and Second Trimming Operations. — Following the second indent, the fifth redrawing operation is accomplished in a No. 857 Toledo press; the production being 150 per hour. The condition of the case

after this operation is shown at *I*, Fig. 144. Before annealing, the mouth end of the case is trimmed because the case becomes quite ragged on the mouth end and would tear in the sixth redrawing operation if the excess stock were not removed. The total length of the case after the fifth redrawing operation averages $10\frac{5}{8}$ inches and it is trimmed to $10\frac{1}{2}$ inches. In many cases, as the punch wears small, it is not necessary to perform this trimming operation because the wall is thicker. The shape of the simple disk cutter is shown in Fig. 149, and the method of trimming the mouth of the case in the Toledo trimming machine is shown in Fig. 150.

Two operators are necessary for this trimming operation; one holds the case on the arbor and the other does the trimming; the production is 350 per hour. Some changes have been made in this machine.

The regular cutter head has been removed and a cross-slide substituted. This cross-slide is operated by a lever, as shown, and carries a toolpost to which a circular friction disk cutter *A* is held. After trimming, the cases are annealed, each pan holding eighty-eight cases.

The sixth redrawing operation is performed on a Toledo



Fig. 147. Third Redrawing Operation on a Toledo No. 57 Press

No. 856 press. The case, at this operation, is quite long so that the production is reduced to 120 per hour, with two operators. In this operation, the important dimension is the thickness of the wall at the mouth; this should be 0.0285 inch. Following this redrawing operation, the case is again trimmed, as shown in Figs. 149 and 150. The pro-



Fig. 148. Second Indenting Operation on a Toledo Press

duction on the trimming machine is 350 cases per hour.

Heading. — After the sixth redrawing and trimming operations, the cartridge case is taken directly to the Toledo heading press, shown in Fig. 151. The operation of this press is as follows: An indexing fixture fastened to the ram of the press carries two heading punches, one being used for forming the primer pocket and the other for flat-



Fig. 149. Close View of Cartridge Case Trimming Machine shown in Fig. 150



Fig. 150. Trimming Mouth End of Case on a Toledo Cartridge Case Trimming Machine

tening out the head. The heading die-holder retained on the bed of the press is also of the indexing type. The die-holder *C* carries two similar shaped heading dies *A* and *D*, each of which carries a bottom plug, or support, for the cartridge case. Assuming that both dies *A* and *D* are empty, the cartridge case is placed over the plug in the die,



Fig. 151. Heading Cartridge Cases on a Toledo Press

then the turret die-holder *C* is indexed, bringing the loaded die in line with the punches. Next, punch *B* is indexed in line with the cartridge case; after this, the press is operated and the first blow delivered. The die-holder now remains stationary and the punch-holder is indexed to bring the flattening punch in line, after which the press is again operated and the second blow delivered. An unheaded case is now loaded in the empty die, and the die turret indexed; this brings the un-

headed case in line with the ram, and the headed case in line with the pick-up *E*. The punch-holder is now indexed to again bring the punch *B* in line, and the press operated. While the blow is being delivered to the second case, the headed case is removed from the die turret by pick-up *E*. The production is 150 cases per hour.

Following heading, the mouth of the shell is annealed previous to the tapering operations that follow. The anneal-

ing is accomplished as shown in Fig. 152. The machine comprises a rotating table carrying twelve plates, which are also rotated, upon which the cartridge cases are placed. Twenty burners fed by natural gas are provided. The large table makes one revolution in one minute and forty seconds, but the cartridge cases are rotated continuously and make thirty-three revolutions to each revolution of the large table. The main rotating fixture carries a large spur gear that meshes with small pinions fastened to the spindles of the plates that carry the cases; hence, as the large fixture rotates, the plates carrying the cases are also rotated. One



Fig. 152. Annealing Mouth in a Special Furnace previous to tapering

revolution of the large table anneals the mouth of the case sufficiently for tapering. The annealing temperature attained at this time is about 800 degrees F. (about 430 degrees C.), which is sufficient to heat the cartridge cases to a cherry-red color. Prior to the tapering operations which follow, the cases are washed in a 10 per cent caustic soda and water solution.

Tapering.— Following the annealing of the mouth of the case, two tapering operations are performed, bringing the case to the final shape shown at *M*, Fig. 144. These operations are performed in Toledo special tapering presses, which are shown in Fig. 153. These machines differ from the or-

dinary punch press in that the stroke of the press is controlled by an eccentric and link motion instead of by a combined crank and toggle action. This mechanism is used owing to the length of stroke necessary and because of the fact that a press used for tapering does not need anywhere



Fig. 153. First and Second Tapering Operations on Special "Toledo" Cartridge Case Tapering Machines

nearly the same strength and power as one that would be used for heavy redrawing, embossing, or forming operations.

In the first tapering operations, the mouth of the case is reduced to $3\frac{3}{8}$ inches in diameter and tapered for a distance

of 6 inches, the diameter at the termination of the taper being $3\frac{5}{8}$ inches. Two men are employed for this operation and the production is 250 per hour. In the second tapering, the mouth of the shell is made straight for one inch and then tapered to the rim on the head at the rate of 0.04066 inch on the diameter for every inch in length. Two men can produce 250 cases per hour on this operation.



Fig. 154. Machining Head and Mouth Ends of Case on a Bullard Cartridge Case Trimming, Facing and Chamfering Machine

Machining Cartridge Cases. — The cartridge case is not finished complete in the punch press, but after tapering, several operations are performed on the head and mouth, and these are handled on the Bullard cartridge case trimming, chamfering and facing machine shown in Fig. 154. The operations are: Rough-bore primer pocket, face head

with facing tool, form with tool on rear of carriage, recess at bottom of primer pocket, tap with Murchey tap, four threads per inch, ream with a combination reamer, and turn and trim open end.

Inspecting and Testing.—The cartridge case is now turned over to the inspectors, when the following gaging

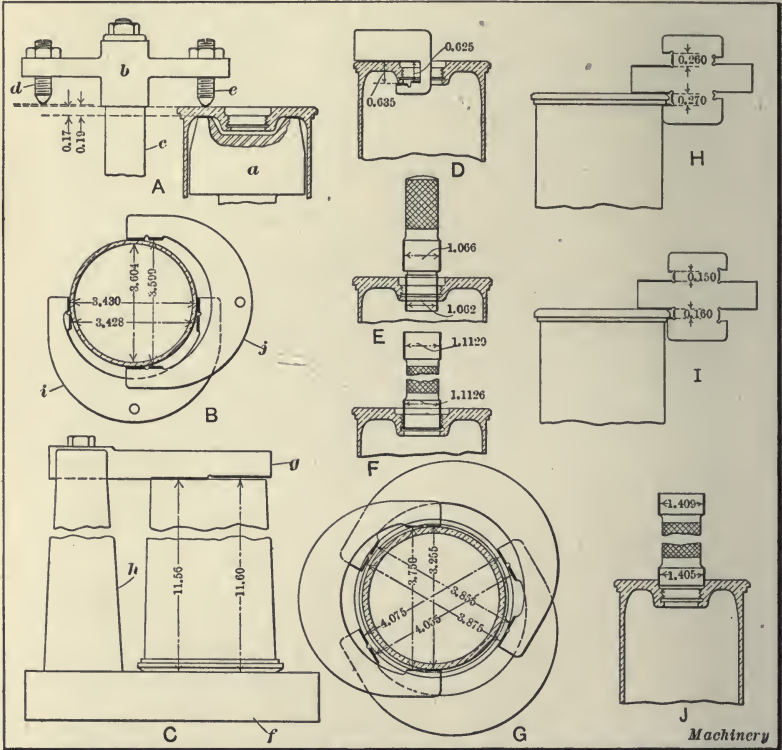

Fig. 155. Diagram showing Application of Various Gages used in Inspecting 18-pound British Cartridge Cases

tests are made: First, gage for thickness of head; second, for tapers; third, over-all length; fourth, thickness through primer hole; fifth, primer hole diameter; sixth, root of thread; seventh, lower rim; eighth, thickness of head; ninth, thickness of head flange; tenth, diameter of counterbore at extreme head of case; eleventh, recess in pocket; twelfth, threads; and thirteenth, gun barrel test.



Fig. 156. Gaging Thickness of Head of Cartridge Case



Fig. 157. Testing Taper of Cartridge Case with Horseshoe Gages

The manner in which these inspection operations are handled is shown diagrammatically in Figs. 155 and 162 and in Figs. 156 to 161, inclusive. The first test that is made is for the thickness of the head, measuring from the inside. This is accomplished as shown in Fig. 156, and diagrammatically at *A*, Fig. 155. The cartridge case is held on a post *a*, and the swinging arm *b* that rests on the shoulder of another post *c* carries two gaging points *d* and *e*, one being set for the maximum and the other for the minimum dimensions. A limit of 0.002 inch is allowed.



Fig. 158. Gaging Over-all Length of Case

Gaging for taper is accomplished by means of horseshoe gages, as shown in Fig. 157, and diagrammatically at *B*, Fig. 155. The upper gage *i* measures at a point 8.25 plus 0.000, minus 0.005 inch from the head and the lower gage *j* at a point 3.428 plus 0.000, minus 0.002 inch from the head. The limit, as shown at *B*, is 0.002 inch for the smaller diameter, whereas the larger diameter has a limit of 0.005 inch. The third test is for over-all length, as shown in Fig. 158, and at *C*, Fig. 155. Here the case is held on a baseplate

f and the gaging bar g is held on a standard h , a limit of 0.040 inch being allowed on the length.

The test shown in Fig. 159 and at D , Fig. 155,



Fig. 159. Gaging Thickness of Flange and Thickness through Primer Hole

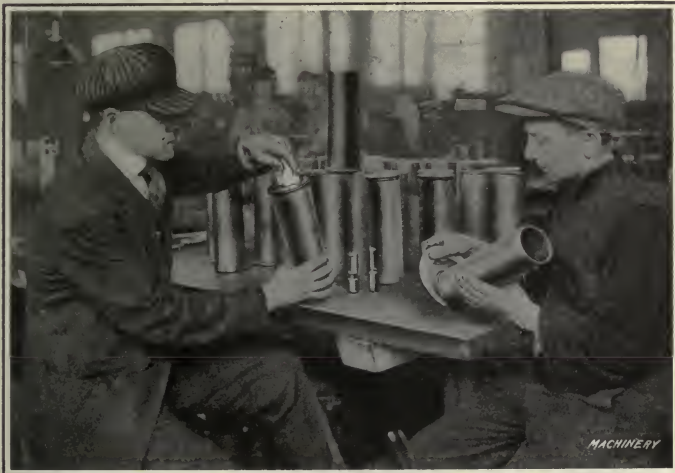

Fig. 160. Gaging Diameter of Head and Depth of Counterbore

is gaging the thickness from the head of the case to the inner face of the pocket. The allowable limit here is 0.010 inch. First, the clearance hole in the primer pocket is gaged

as shown at *E*, Fig. 155; afterwards, the root diameter of the threaded hole is tested, as shown at *F*. Following this, the diameter of the head of the case is tested, as shown to the right in Fig. 160, and at *G*, Fig. 155. Here the head is gaged at three points, the limits being as shown at *G*.

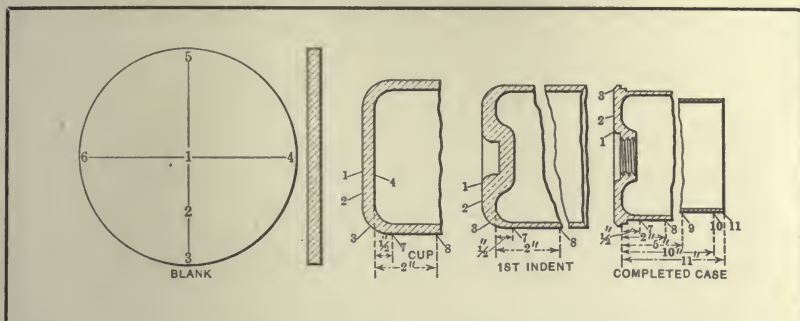

Fig. 161. Making Gun Barrel Test

The final gaging operations are shown at *H*, *I*, and *J*, Fig. 155, and in Figs. 161 and 162. The thickness of the head is gaged as shown at *H* and *I*, and also to the right in Fig. 159. The gage used is of the double-ended type, so that the two thicknesses can be measured with one gage. The next test is to gage the diameter of the counterbore in the head of the cartridge case as shown at *J*. Following this, the last and final test is made; this is the gun barrel

test shown in Figs. 161 and 162. This gage comprises a cylindrical cast-iron tube, which is machined inside to the same dimensions as the bore of the barrel, as shown in Fig. 162, and

TABLE VII. SCLEROSCOPE READINGS INDICATING HARDNESS OF METAL AFTER EACH ANNEALING AND REDRAWING OPERATION



Operation	Time of Test	Points at which Readings are Taken										
		1	2	3	4	5	6	7	8	9	10	11
Blanking	A*	15	14	14	14	15	14
Cupping	B	20	26	31	19	50	40
Annealed	A	12	12	12	11	13	12
First Redrawing	B	11	13	19	14	36	50
Annealed	A	12	12	12	11	12	11
Second Redrawing	B	12	10	12	36	50	50
First Indenting	B	34	35	22	44	44	46
Annealed	A	11	11	11	15	14	14
Third Redrawing	B	11	12	12	36	41	48
Annealed	A	10	11	12	12	14	15
Fourth Redrawing	B	11	11	12	31	38	44
Second Indenting	B	12	26	34	34	51	51
Annealed	A	10	11	12	12	14	14
Fifth Redrawing	B	14	12	15	32	35	41	41	..
Annealed	A	11	13	14	15	11	14	15	..
Sixth Redrawing	B	13	20	15	22	30	31	41	42
Heading	..	16	38	47	28	32	33	44	45
Mouth Anneal	..	16	38	46	26	30	31	22	12
Second Taper	..	16	37	46	35	38	44	36	59

Machinery

* Note: "A" is scleroscope reading before, and "B" after annealing.

two supporting stands. The cartridge case is pushed into this gage, and by laying a scale across the gage, the head of the cartridge case must come slightly below flush. The case should be easily inserted and extracted from this gage.

Testing Cartridge Cases for Hardness.—In order that the final product will be according to specifications, each drawing and annealing operation must be carefully followed. The method generally adopted by various manufacturers engaged in this work is to use the scleroscope and test the hardness of the case before and after each redrawing or annealing operation. Table VII gives the readings taken on the cartridge case after each operation, and the diagram with this table shows the points at which the readings are taken. It is the practice of this plant to “scleroscope” 1 per cent of its daily product; therefore, on a product of 4000 cartridge cases in ten hours, forty cases, after

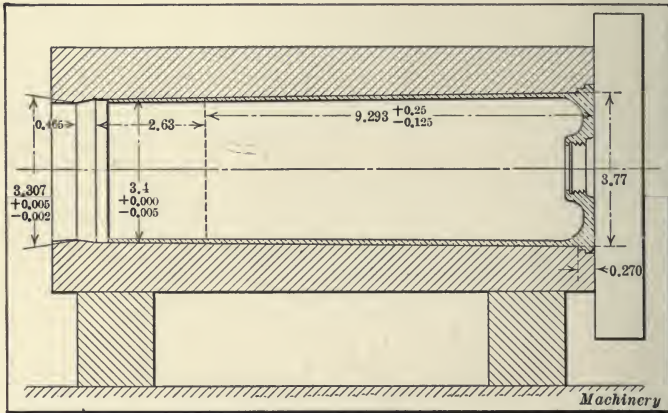

Fig. 162. Diagram showing Gage used for Gun Barrel Test

the completion of each operation, as shown in Fig. 163, are taken to the testing department where scleroscope readings are taken. These readings are then charted and compared with other tests.

Making Primers for Cartridge Cases.—The percussion primer, carried in the head end of the cartridge case and used for igniting the propelling charge, comprises six parts, as shown in Fig. 164. Of these, the body A is the most difficult to make. This is made from 1 7/16-inch round bar stock, either in a hand or automatic screw machine. In one plant turning these parts out in large quantities, a Gridley 1 3/4-inch multiple-spindle automatic screw machine, as

shown in Fig. 165, is used for performing the first series of operations. The order of operations is as follows: Rough-counterbore and form, drill and countersink, thread external diameter, and finish-ream, cut off, and feed stock. The spindles of the machine are rotated so as to give a speed of 90 surface feet for the forming cut. The production is eighty per hour.

The second operation on the body consists in facing and shaving the head; this is done on a hand screw machine of the Pratt & Whitney type. The work is rotated to give a

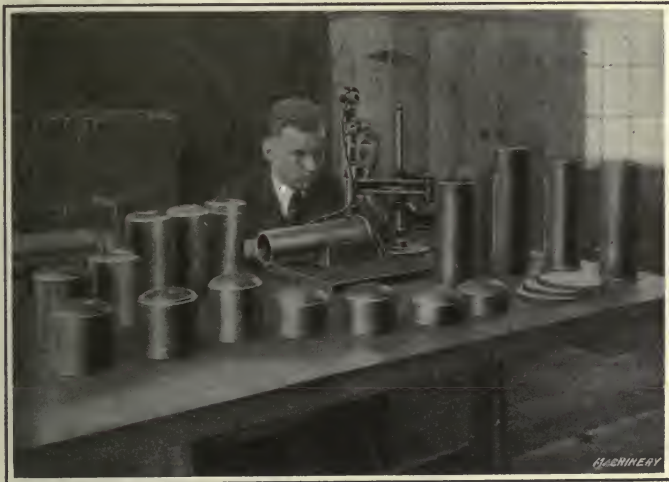

Fig. 163. Testing Hardness of Cartridge Case with Scleroscope

surface speed of 125 feet per minute, and the production is 250 per hour. The third operation is milling the key slots in the base in a Brown & Sharpe hand milling machine, using a simple indexing fixture. The end-mill used is operated at 200 feet surface speed, and one cut finishes each slot. The production is 140 per hour. The fourth operation, reaming the tap hole and the smaller hole in the base of the body, is done in a Henry & Wright two-spindle drilling machine carrying a combination reamer. The work is held in a fixture that can be slid along the table, being controlled in its movement by guide strips fastened to the

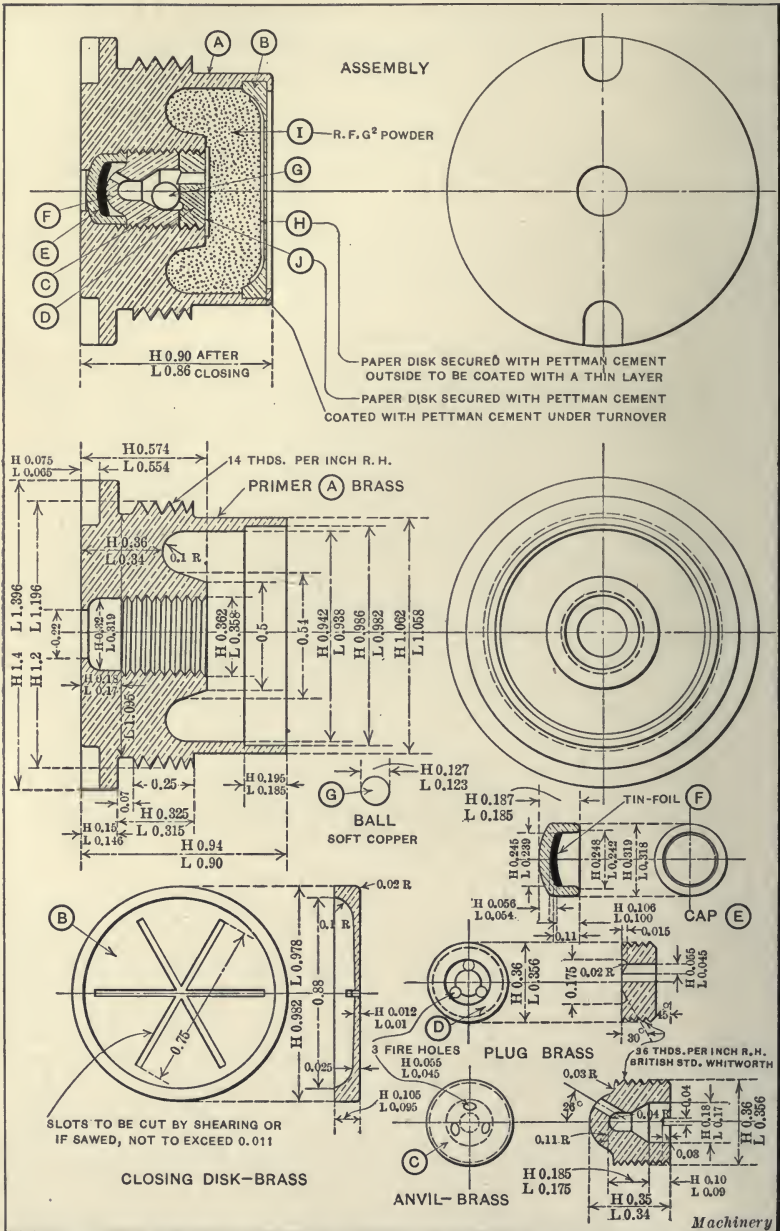

Fig. 164. Assembly View and Details of British Cartridge Case Primer

table. Two tools are used, one for roughing and the other for finishing, the surface speed being about 200 feet. The production on this operation is about 150 per hour.

The fifth operation is to tap the small hole in a tapping machine with a tap operating at a surface speed of 30 feet per minute. The work is held in a jig and the production is 120 per hour. The sixth operation is to finish-ream the percussion cap hole in a Henry & Wright drilling machine. This is a very difficult operation to accomplish because the

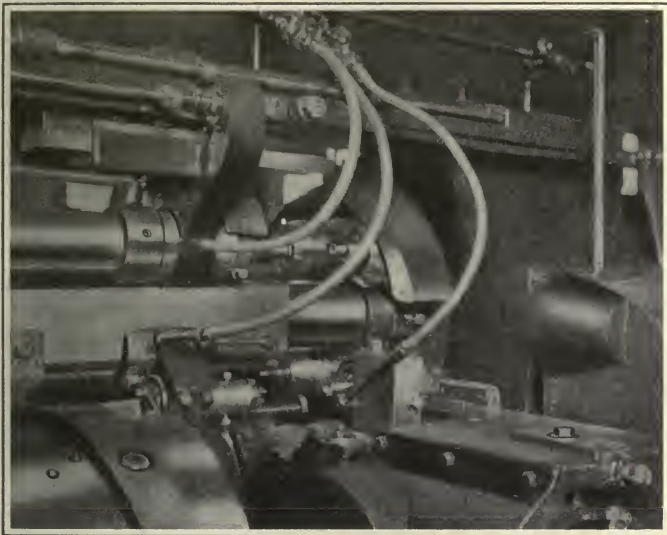

Fig. 165. Machining Cartridge Case Primer Body on a Gridley 1 $\frac{1}{4}$ -Inch Automatic

accuracy required is ± 0.0005 inch. The surface speed of the tool has to be cut down to 80 feet; and the production is 100 per hour. The seventh operation is to stamp the required letters on the base of the primer with a hand stamp, three sets of stamps being required. The production is 150 per hour. The eighth is to lacquer the exterior with a brush. The lacquer used consists of: Seedlac, 10.54 per cent; turmeric, 5.26 per cent; spirits, methylated, 84.2 per cent. This is done at the rate of 200 per hour. The ninth operation is inspecting.

Making the Disk.— The closing disk *B*, Fig. 164, for the primer is made from 1-inch diameter brass rod in a $1\frac{1}{4}$ -inch Gridley multiple-spindle automatic screw machine. The order of operations is as follows: Form and cup, shave, finish cup, and cut off and feed stock. The stock is operated at a surface speed of 110 feet, and the production is at the rate

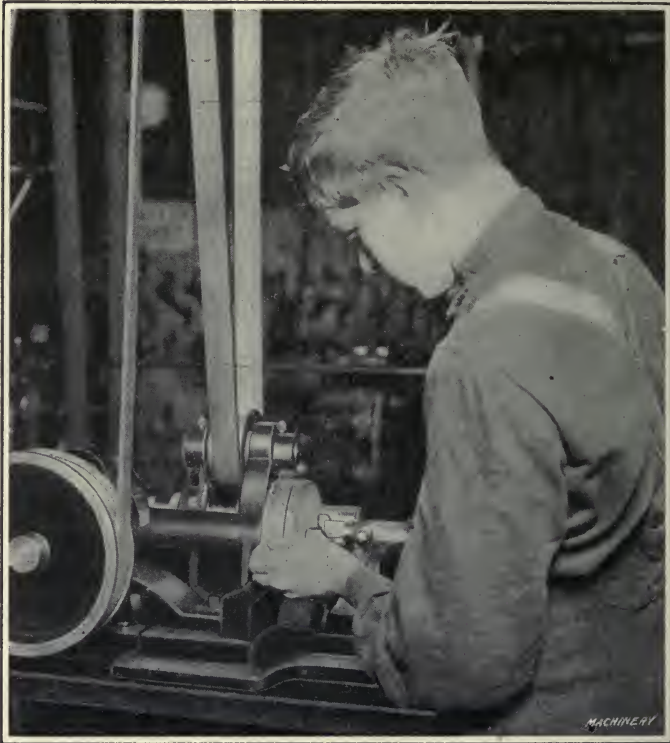

Fig. 166. Slotting Anvils in a National-Acme Screw Slotting Machine

of 20 seconds a piece. The second operation is to remove the burrs on a small stand grinder. The third operation is to slit and straighten in a small Brown-Boggs punch press. The fourth is to inspect.

Making the Anvil.— The anvil *C*, Fig. 164, is made on a No. 00 Brown & Sharpe automatic screw machine from $\frac{3}{8}$ -inch round bar stock. The order of operations is: Feed

stock to stop, form and bore, ream small hole, thread and cut off, burr in the burring attachment. The stock is rotated at 2400 R. P. M. for forming and at 2400 R. P. M. for threading. The production is 400 per hour. The second operation is slotting, which is accomplished in a National-Acme screw slotting machine as shown in Fig. 166; the production is about 800 per hour. The third operation is drilling, which is accomplished in a Leland-Gifford high-speed drilling machine as shown in Fig. 167. The drill used is size No. 55 (0.052 inch) and is operated at 10,000 R. P. M. An indexing fixture is used, and it requires three indexes to complete the drilling. The production is 400 per hour. The fourth operation is inspecting.

Making the Plug.—

The plug *D*, Fig. 164, is also made on a No. 00 Brown & Sharpe automatic screw machine from $\frac{3}{8}$ -inch round bar stock. The order of operations is: Feed stock to stop, form and groove, thread, cut off, burr



Fig. 167. Drilling Fire-holes in Anvil in a Leland-Gifford High-speed Drilling Machine

with burring attachment. The spindle speed is 2400 R. P. M. and the production is 600 per hour. The three fire holes are also drilled in the Leland & Gifford high-speed drilling machine shown in Fig. 167, using an indexing attachment. The drill is operated at 10,000 R. P. M., and 400 per hour are turned out. A different jig is used for drilling the plug from that used for the anvil. In the case of the plug, the holes are drilled parallel with the axis, and in the anvil at an angle of 26 degrees with the axis. The percussion cap *E*, Fig. 164, is made in a small punch press in one operation, a combination blanking and cupping punch and die

being used. The soft copper ball *G* is a standard product of the ball manufacturers.

Assembling and Loading.—Up to the present time, few of the manufacturers that have taken orders for primer parts are assembling and loading them. This delicate and somewhat dangerous operation is generally handled in the government arsenals or in cartridge factories regularly devoted to this work. Manufacturers that have taken orders for complete rounds of ammunition, however, may be called upon to handle this work in the future. Before the primer can be assembled, the copper cap *E*, Fig. 164, must be charged. This is made on a double-action punch press, and is blanked and cupped in one operation. After cupping, it is cleaned, dried and then coated with a varnish containing the following constituents: Finest orange shellac, 20 per cent; spirits (methylated), 80 per cent. The next operation is charging the cap with 1.2 grain of the following explosive composition:

Constituents	Parts (by weight)
Sulphide of Antimony.....	18
Chlorate of Potash.....	12
Glass (ground)	1
Powder (mealed)	1
Sulphur	1

For charging, the caps are held on one plate, and a second plate called a "charger," having the same number of holes as the cap-plate, is located over the caps, and the explosive charge held in the plate is deposited in the cap. The cap-plate is then taken to a fulminate pressing press, where the charge in the cap is compressed by means of punches under a pressure of 800 pounds. The next step is to lacquer sheets of tin foil on one side with the following composition: Seedlac, 10.52 per cent; turmeric, 5.26 per cent; spirits, methylated, 84.22 per cent. Disks are then cut out from this tin foil and pressed into the cup under 400 pounds pressure, the lacquered side outward. The primer cup is then coated with the same varnish as that used on the cap previous to charging. The cap is now coated externally

with Pettman's cement which is composed of the following ingredients:

Ingredients	Per Cent
Gum Shellac	18.18
Spirits, methylated	19.39
Tar, Stockholm	12.12
Red, Venetian	50.31

The primer is now ready for loading, and the first part to be assembled is the cap *E*. Before this is placed in the body *A*, however, the pocket in the latter is coated with Pettman's cement. The parts are then put in, in the following order (see Fig. 164): Cap *E*, anvil *C*, soft copper ball *G*, and brass plug *D*. Plug *D* is locked in place by three small punch blows, after which the fire holes are covered with a paper disk *J* that is secured with Pettman's cement. The primer cavity is now filled with R. F. G.' powder, and the brass closing disk *B*, with paper disk *H* attached to the inner surface by Pettman's cement, is then put in place. This is finally held in place by spinning over the edge of the primer body, as shown in Fig. 164. The last operation is to coat the outer surface of disk *B* with Pettman's cement, after which the primers can be turned over to the inspectors.

CHAPTER XI

MAKING CASES WITH BULLDOZERS AND PLANERS

THE manufacture of cartridge cases is usually carried on by means of power presses of the crank and flywheel type, but many manufacturers have had to resort to other methods of handling the work. In one case, where car-shop equipment is used for this work, all the cupping, redrawing, and tapering operations are accomplished on bulldozers and frog and switch planers which have been fitted up for this purpose. The only special machine that had to be purchased to complete the cartridge case, with the exception of the machining operations, was a hydraulic heading press. The order of cupping and redrawing operations is shown in Fig. 168, and in Table VIII, which includes all the data—machines used, production, scleroscope readings, etc.

Cupping. — In this plant, the blank is obtained of the correct size and thickness, and in the annealed condition. The first operation, therefore, is cupping, as shown at *A*, Fig. 168 and in Fig. 169. For this work, a Niles-Bement-Pond bulldozer is used. The die is held on the cross-head and the punch on a fixture attached to the bed of the machine. This particular machine is fitted up for accomplishing both the cupping and first redrawing operations, the punch shown at *A* performing the cupping and that at *B* the first redrawing. In this way, two men can operate the machine and thus turn out a cup and perform the first redrawing operation at each stroke of the machine. A lubricant known as "Viscosity" and made by the Cataract Refining Co. is used for lubricating the die and punch.

Annealing. — Following the cupping operation, the cases are annealed in a Quigley oil furnace, as shown in Fig. 170. The cases are held in a sheet-iron pan having a wire bottom and are brought to the furnace on a truck, as shown, the

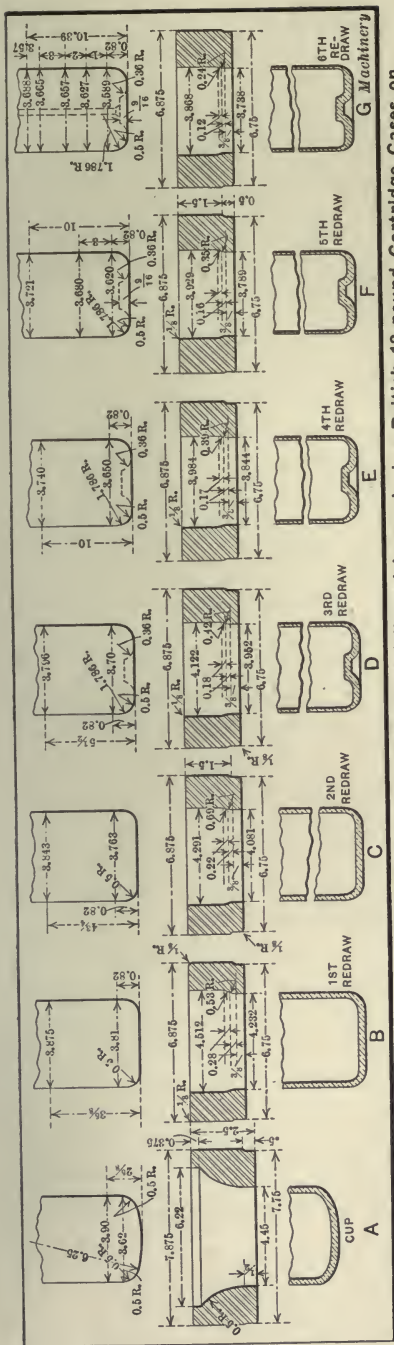

Fig. 168. Punches and Dies used and Sequence of Operations followed in producing British 18-pound Cartridge Cases on Frog and Switch Planers

platform of which is provided with rollers. As soon as the pan carrying the cases is brought in line with the door of the furnace, the air jack shown is operated, forcing the pan into the furnace. The door is then closed and the cases annealed. This furnace is kept at a constant temperature of between 1100 and 1140 degrees F. (593 and 616 degrees C.), and holds seven boxes, each box carrying 140 cases. It requires thirty-five minutes for one lot of cases to pass completely

through the furnace, so that one box is taken out and one put in the furnace every five minutes. As the pan of cases is removed from the unloading end of the furnace, Fig. 171, it slides on a platform operated by an air jack in a similar manner to an elevator. This arrangement is located over a cooling bath and is operated to immerse the cases in the cooling bath. When cool, the platform raises the pan of cases, which is then rolled out on to the truck and carried over to the pickling bath shown

TABLE VIII. OPERATIONS ON 18-POUND, BRITISH, CARTRIDGE CASE

No. of Operation	Character of Operation	A Inches	B Inches	Machine Used	Lubricant	Furnace Used	Temperature of Furnace, Degrees F.	Bath	Scleroscope Reading	Production Per Hr.
1	Blanking	4.45	2.30	Punch Press	15
2	Cupping	Bulldozer	a, 15; b, 50	300
3	Annealing for 35 Minutes	Oil	1100 to 1140	Water Cooling Acid Wash	15	300
4	1st Redrawing	4.232	3.45	Bulldozer	a, 15; b, 50	300
5	Annealing for 35 Minutes	Oil	1100 to 1140	Water Cooling Acid Wash	15	300
6	2nd Redrawing	4.081	4.6	Bulldozer	a, 40; b, 45	300
7	Annealing for 35 Minutes	Oil	1100 to 1140	Water Cooling Acid Wash	15	300

Machinery

TABLE VIII. OPERATIONS ON 18-POUND, BRITISH, CARTRIDGE CASE—CONTINUED.

No. of Operation	Character of Operation	A Inches	B Inches	Machine Used	Lubricant	Furnace Used	Temperature of Furnace, Degrees F.	Bath	Scleroscope Reading	Production Per Hr.
8	1st Indenting	4.081	4.23	Bulldozer	Viscosity	a, 18; b, 15	300
9	3rd Redrawing	3.952	6.25	Bulldozer	Viscosity	a, 18, b, 45	300
10	Annealing for 35 Minutes	Oil	1100 to 1140	Water Cooling	a, 13; b, 15	300
11	4th Redrawing	3.844	7	Bulldozer	Viscosity	Furnace	Acid Wash	a, 35; b, 45	300
12	Annealing for 35 Minutes	Oil	1100 to 1140	Water Cooling	15	300
13	2nd Indenting	3.844	6.875	Bulldozer	Viscosity	Furnace	Acid Wash	a, 18; b, 15	300
14	Drill Hole in Primer Pocket	Vertical Drilling Machine	300
15	Trimming and Burring	3.844	6.25	Toledo Trimmer	175
16	5th Redrawing	3.789	9.75	Frog and Switch Planer	Vaseline	a, 20; b, 40	200
17	Annealing for 35 Minutes	Oil	1100 to 1140	Water Cooling	a, 20; b, 16	180
18	6th Redrawing	3.738	13.35	Frog and Switch Planer	Vaseline	Furnace	Acid Wash	a, 20; b, 45	300
19	Trimming	3.738	11.875	Toledo Trimmer	180
20	Heading	3.738	11.750	350ton, C.P.R.	200
21	Annealing Mouth for 35 Seconds	Hydr. Press	Oil	800	Cool in Air	a, 40 to 50; b, 50	100
22	1st Tapering	3.347	11.875	Bulldozer	Dry	Burner	a, 40 to 50; b, 25 to 35	180
23	2nd Tapering	3.328	11.95	Bulldozer	Dry	a, 40 to 50; b, 35 to 40	300
24	Machining Mouth and Head	Bullard	Mystic	a, 40 to 50; b, 35 to 45	300
25	Hand Tapping	Case Machine	40
26	Reaming	Bench Fixture	80
27	Inspecting	Bench Fixture	80
28	Stamping	Various Gages	80

to the right of the illustration. Here the pan is again picked up by an air jack and dipped in the weak sulphuric acid solution used in removing the scale. Following this, the cases are immersed in a hot-water solution.

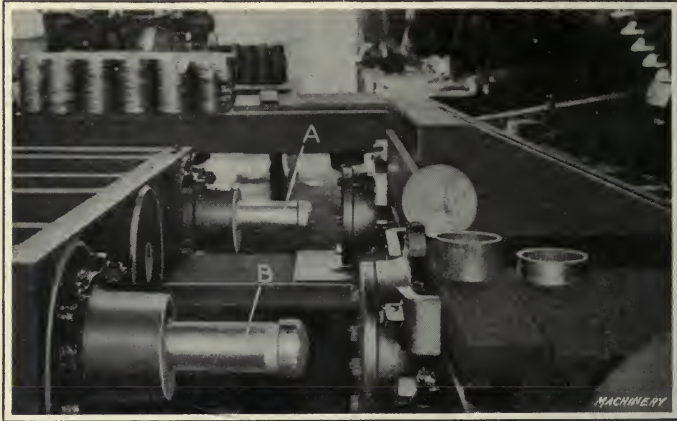

Fig. 169. Performing Cupping and First Redrawing Operations on a Nilas-Bement-Pond Bulldozer



Fig. 170. Annealing Cartridge Cases In a Quigley Oil Furnace for Thirty-five Minutes

First, Second, and Third Redrawing and Indenting Operations. — After annealing and washing, the cases are taken back to the Nilas-Bement-Pond bulldozer, shown in Fig.

169, and the first redrawing operation is performed as previously described. They are again annealed, washed, etc. Following this, the second redrawing operation is performed on a Williams & White bulldozer, where the punch and die are held in the same manner as for the first redrawing operation. Annealing, washing, etc., follows the second redraw. The head end of the cartridge case is now indented in a Williams & White bulldozer, where the base end is formed to the shape shown at *D*, Fig. 168, and is then given the third redrawing operation without annealing as shown in Fig. 172. Here the operator removes the case from a



Fig. 171. Immersing Cases in Cooling and Pickling Baths following Annealing

tank which is filled with a lubricant—"Viscosity"—and places it on the punch, as illustrated, when the cross-head is on the backward stroke.

Following the third redrawing operation, the case is again annealed, washed, etc., and is then taken to the Williams & White bulldozer, where the fourth redrawing operation is accomplished. After the fourth redrawing operation, the case is annealed, and then taken to the second indenting operation. This is accomplished in a Williams & White bulldozer at the rate of 300 per hour.

At this point, an operation is performed that is not general practice; a $\frac{1}{4}$ -inch hole is drilled through the primer

pocket. In attempting to form the head of the cartridge case with the primer pocket solid, it was found that the metal in the proximity of the pocket was much harder than



Fig. 172. Third Redrawing Operation on Williams & White Bulldozer

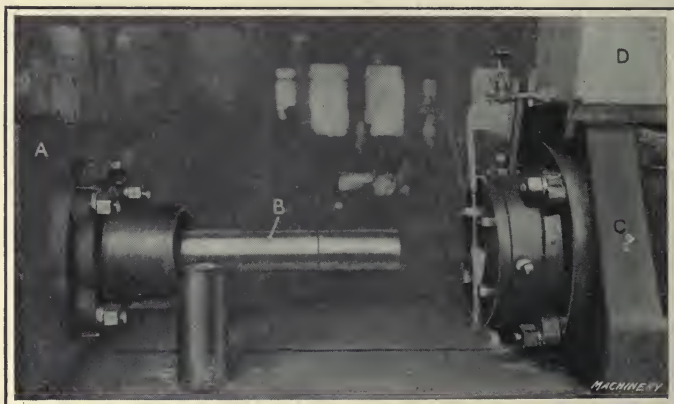

Fig. 173. Performing Fifth Redrawing Operation on a Frog and Switch Planer

at the rim. This is just the reverse of what is required; in other words, the rim must be much harder than the center of the head. But, a hole drilled through the pocket, in the heading, allows the metal to flow freely to the center,



Fig. 174. Heading Cartridge Cases on a C. P. R. Heading Machine



Fig. 175. Mouth-annealing Cartridge Case In an Improvised Annealing Furnace

and thus prevents "packing" and subsequent hardening. Following the drilling of the hole in the primer pocket, the

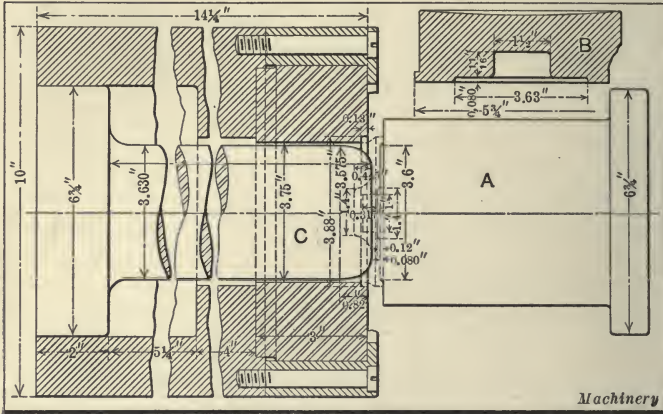

Fig. 176. Diagram showing Dies and Heading Tools used in Machine shown in Fig. 174

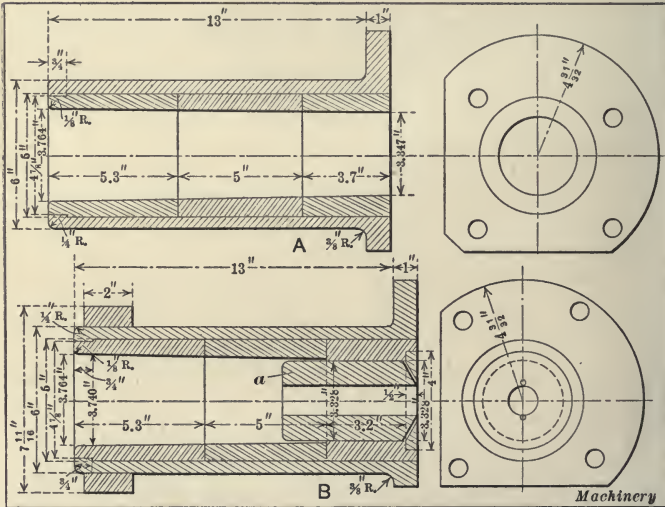

Fig. 177. Dies used for First and Second Tapering Operations on Cartridge Case

case is taken to a Toledo case trimmer, where the open end is trimmed, removing the ragged edge from the mouth of the case.

Fifth and Sixth Redrawing Operations.— The fifth and sixth redrawing operations are handled on a frog and switch planer, as shown in Fig. 173. The entire cross-rail has been removed and a large casting *A*, serving as a punch-holder, is fastened to the uprights. The redrawing punch *B* is therefore held stationary. The redrawing die, on the other hand, is held in a holder retained on casting *C* bolted to the planer table. The method of operating is to place the



Fig. 178. Hand-reaming Primer Pocket in Head of Cartridge Case

case on the punch when the planer table is on the return stroke. The punch and die is lubricated by a lubricant held in box *D*, which, of course, travels with the die. The case, in being forced through the die, slides down a trough into a box.

After the fifth redraw, the case is annealed, washed, etc.,

and is then given a sixth redraw which is accomplished in a similar manner to the fifth. The mouth of the shell is again trimmed on the Toledo case trimmer and from here is taken, without annealing, to the heading press.

Heading. — The heading operation is now performed in the 350-ton press shown in Fig. 174, which is built by the Canadian Pacific Railway. This machine is provided with



Fig. 179. Testing Hardness of Cartridge Cases with Scleroscope

a table of the indexing type which carries four sets of dies, shown in detail in Fig. 176. In heading, the case is given two blows; the first is delivered by punch *A*, which fills in the primer pocket. Punch *B*, which is held on a rod, as shown in Fig. 174, is then placed over the case and a flattening blow is delivered. While these operations are being performed, the case is supported by punch *C*, Fig. 176.

Mouth-annealing and Tapering. — The next operation is mouth-annealing, which is accomplished in the simple furnace shown in Fig. 175. It comprises a stand which supports an air drill, a spindle *A*, fitted into the driving socket of the drill, and a table attached to this as shown. The case is supported on this table and rotated by the air drill; the annealing is done with an oil burner. The case is allowed to rotate for thirty-five seconds and is heated to a temperature of 800 degrees F. (427 degrees C.) for a dis-

tance of about from $4\frac{1}{2}$ to 5 inches from the mouth of the case.

After mouth-annealing, the cases are allowed to cool off in the air, and when cool are taken to a Williams & White bulldozer. Two tapering operations are necessary to bring the case to the correct shape and size. The dies used for this purpose are shown in Fig. 177. The first tapering die, shown at A, is made in three pieces. For the first tapering, the mouth of the shell is not supported, as the reduction is carried along the entire body. In the second tapering, however, the reduction at the mouth is greater and necessitates using a supporting bushing *a*, as shown at B.

Machining Head and Mouth Ends of Case. — Following the tapering operations, the cartridge case is taken to the machining department where a series of operations is performed, on the head and mouth ends, on a Bullard facing, chamfering, and trimming machine. The order of operations is: Rough-drill and counterbore, face, trim, and chamfer head, finish-chamfer and face, under-cut primer seat, finish-counterbore, tap with collapsing tap, trim and chamfer mouth.

The case is now taken to a special reaming fixture, shown in Fig. 178, where the primer pocket is finish-reamed. Hand tapping of the primer pocket follows this and is accomplished in a similar fixture. The case then passes through a series of inspection operations, consisting in gagging the diameter and thickness of the head, depth, diame-

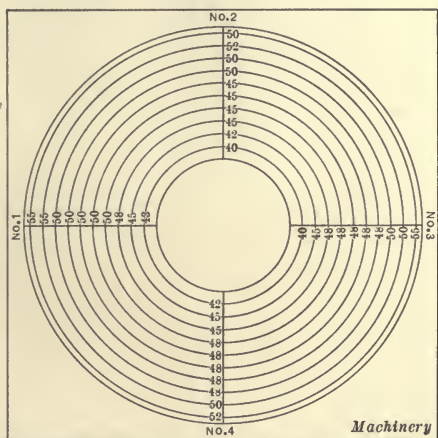

Fig. 180. Diagram showing Representative Scleroscope Reading taken on Head of a Cartridge Case

ter, etc., of the primer pocket; over-all length, diameter of mouth, etc. Another inspection is looking through the case, from the head end, to detect whether any free spelter is present or not. The cartridge case is then stamped on the head end in a Noble & Westbrook stamping machine. This finishes the machining and inspection operations on the case.

Testing for Hardness.—The hardness of the metal is tested before and after each annealing and redrawing operation, and, for this purpose, the scleroscope is used. Fig. 179 shows an inspector taking a series of readings on the head of the cartridge case. About one per cent of the daily production is inspected in this manner, and Fig. 180 shows a representative reading. The body of the case is also tested for hardness at the points indicated in the illustration accompanying Table VIII. This table also includes the scleroscope readings obtained before and after every annealing and redrawing operation. For taking a reading on the body of the case, it is placed on the horn A, Fig. 179. Final inspection, packing, etc., finishes the operations on the case.

CHAPTER XII

COST OF MUNITIONS OF WAR

At this time when the principal nations of Europe are at war and the question of increasing the defenses of the United States is being agitated, a few figures on the cost of guns, etc., will be of interest. The following data on the cost of guns, howitzers, mortars, mountings, carriages, projectiles, powder charges and fuses were furnished by the ordnance departments, Washington, D. C., and are therefore authoritative:

3-inch field gun.....	\$ 1,825.00
4.7-inch field gun.....	4,650.00
4.7-inch howitzer	2,150.00
6-inch howitzer	3,325.00
6-inch seacoast gun.....	6,700.00
12-inch seacoast mortar.....	11,000.00
14-inch seacoast gun.....	55,000.00

The costs of carriages and mountings for seacoast guns are:

15-pounder barbette	\$ 5,000.00
5-inch barbette	13,500.00
6-inch barbette	14,000.00
6-inch disappearing	24,000.00
10-inch disappearing	37,000.00
12-inch disappearing	65,000.00
14-inch disappearing	85,000.00
16-inch disappearing	130,000.00
12-inch mortar	18,000.00

The cost of artillery carriages of the mobile or transportable type is as follows:

3-inch field gun carriage.....	\$ 2,181.00
3.8-inch howitzer carriage	8,500.00

3.8-inch gun carriage.....	\$ 5,462.00
4.7-inch howitzer carriage	10,562.00
4.7-inch gun carriage	4,361.00
6-inch howitzer carriage.....	14,147.00

If manufactured in the government plant, a round of ammunition costs approximately as given in the following, but when purchased from manufacturers, the cost is higher.

3-inch field gun	\$ 10.00
4.7-inch gun	28.00
6-inch howitzer	43.00
3-inch, 15-pounder	15.00
6-inch	60.00
12-inch gun	500.00
12-inch mortar	300.00
14-inch gun	800.00
16-inch gun	1,200.00

The smokeless powder for seacoast ammunition costs 53 cents a pound when purchased and somewhat less when manufactured by the government.

Following are data on the cost of naval guns, carriages, etc.:

3-inch naval gun.....	\$ 3,973.00
5-inch naval gun.....	7,600.00
7-inch naval gun.....	21,850.00
12-inch naval gun.....	72,820.00
14-inch naval gun.....	112,000.00
3-inch gun mounting.....	2,500.00
5-inch gun mounting.....	9,860.00
7-inch gun mounting.....	11,000.00
12-inch gun mounting.....	52,357.00
14-inch gun mounting.....	44,000.00
3-inch projectile	1.97
5-inch projectile	8.72
7-inch projectile	62.00
12-inch projectile	165.00
14-inch projectile	400.00
3-inch gun powder charge.....	2.12
5-inch gun powder charge.....	9.40

7-inch gun powder charge.....	\$	30.60
12-inch gun powder charge.....		147.40
14-inch gun powder charge.....		201.40
3-inch gun fuse.....		0.80
5-inch gun fuse.....		1.45
7-inch gun fuse.....		4.80
12-inch gun fuse.....		4.80
14-inch gun fuse.....		4.80

The cost of a torpedo is \$8500 and of the explosive \$350.

A navy rifle complete costs \$20; pistol, \$18. The navy pays 53 cents a pound for smokeless powder and 14 cents a pound for black powder.

The following data of costs of armor plates and shells have been compiled from bids of private concerns:

4-inch naval gun shells.....	\$	9.50
5-inch naval gun shells.....		12.00
14-inch naval gun shells.....		415.00
7374 tons armor plate, per ton.....		435.00
401 tons armor plate, per ton.....		486.00
290 tons armor plate, per ton.....		466.00
63 tons armor plate, per ton.....		376.00

INDEX

	PAGE
A dapter, machining	177
Ammunition, fixed	23
Annealing cartridge cases.....	184, 212
Anvils for primers, making.....	208
Armor-piercing shells, forging.....	52
Armor-piercing projectiles	9
Assembling fuses	178
Assembling primers	210
B anding howitzer shells	143
Benzol	39
Blanking cartridge cases.....	181
British 18-pounder shell	5
machining	53
British detonating fuse, manufacture of.....	163
British high-explosive fuse	17
pellet charge	19
British howitzer shells	127
British shell blanks, forging	42
Bulldozers used for making cartridge cases.....	212
C apped projectiles	11
Cartridge cases, manufacturing with bulldozers and planers.....	212
manufacture	181
Center plug for fuses, machining.....	179
Chlorate of potash, American composition.....	28
British composition	30
Chlorates	40
Combination primers	30
Concussion fuse	15
Conveying apparatus for rapid handling of shells.....	161
Copper bands, pressing on and forming.....	78, 120, 135
Cordite	37
Cost of munitions of war.....	225
Cupping cartridge cases	181
D elay-action fuse shells	4
Detents, machining	176

	PAGE
Detonating fuse, manufacture of.....	163
Disks for primers, making.....	208
Dunnite	5, 40
E lectric primers	28
Emmensite	38
Explosives, classification	32
F ixed ammunition	23
Forging high-explosive shells	42
French 75-millimeter shell	7
French 120-millimeter shell, inspection	123
machining	100
testing for strength	126
Friction primers	27
Fulminate of mercury	40
Fulminates	40
Fuses, assembling	178
delay-action	4
British high-explosive	17
British high-explosive, manufacture of	163
Russian high-explosive	20
general description	13
G aging cartridge cases	198
Gas plugs	77
Gain parts, machining	178
Grinding high-explosive shells	154
Guncotton, manufacture of	34
Guncotton press	35
Gunpowder	33
H ardness testing of cartridge cases.....	204, 224
Hardness testing of high-explosive shells.....	152
Heading cartridge cases	192
Heat-treating Russian shells	81
High-explosives	38
High-explosive shells, development.....	1
forging	42
types	2
Howitzers, loading	24
shells, machining	127
I ndenting cartridge cases.....	186, 216
Inspecting British shells.....	75

	PAGE
Inspecting cartridge cases.....	198
Inspecting French shells.....	123
L oading primers	210
Lyddite	38
M achining British 18-pound shells.....	53
Machining cartridge cases.....	197, 223
Machining French shells	100
Machining howitzer shells	127
Machining Russian shells	80
Machining Serbian shells.....	88
Maximite	38
Melenite	38
Mortars, loading	24
Munitions of war, cost of.....	225
N itrobenzole	38
Nitronaphthaline	38
O give, machining	92
P ellet, machining percussion	176
Percussion fuse, American.....	15
Percussion pellet, machining	176
Percussion primers	28
Picric acid	39
Planers used in making cartridge cases.....	212
Plugs for primers, making.....	209
Plugs, gas	77
Powder, black	33
smokeless	34
Primers, for cartridge cases.....	27
making	204
Projectiles, armor-piercing	9
capped	11
Pyrocellulose, manufacture of	34
R edrawing cartridge cases.....	186, 216
Russian 3-inch shell	7
Russian high-explosive fuse.....	20
Russian shell blanks, forging.....	46
Russian shells, machining.....	80

	PAGE
S erbian shells, machining	88
Shell fillers	38
Shell manufacture, tools and devices for.....	145
Shimose	38
Smokeless powder	34
T esting cartridge cases.....	198
for hardness	204, 224
Testing French shells	126
Testing hardness of shells.....	152
Tools and devices for shell manufacture.....	145
Trinitrotoluol	39
V arnishing shells	65, 159
Serbian shells	95

338017

UF760
H26
Hamilton

UNIVERSITY OF CALIFORNIA LIBRARY

